

ORDER INFORMATION

SPECIFICATIONS

RATED CURRENT: 3 A AC,DC
 RATED VOLTAGE: 250 V AC,DC
 OPERATING TEMPERATURE: -40°C~+105°C 
 CONTACT RESISTANCE: ≤10 mΩ
 INSULATION RESISTANCE: ≥1000 MΩ
 DIELECTRIC STRENGTH: 800 V AC, 1 MINUTE

MATERIAL

HOUSING: NYLON 66, UL94V-0
 TERMINAL: BRASS



5 W 2 5 0 5 R 0 - 1 X X X X X X L A 0 1

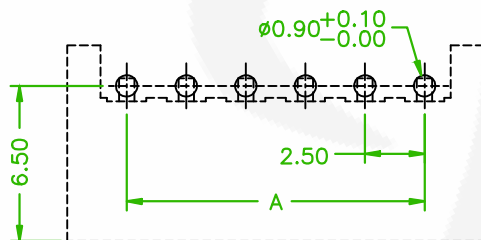

NO. OF CONTACTS PER ROW	Dimensions		NO. OF CONTACTS PER ROW	Dimensions	
	A	B		A	B
02P	2.50	7.50	09P	20.00	25.00
03P	5.00	10.00	10P	22.50	27.50
04P	7.50	12.50	11P	25.00	30.00
05P	10.00	15.00	12P	27.50	32.50
06P	12.50	17.50	13P	30.00	35.00
07P	15.00	20.00	14P	32.50	37.50
08P	17.50	22.50	15P	35.00	40.00



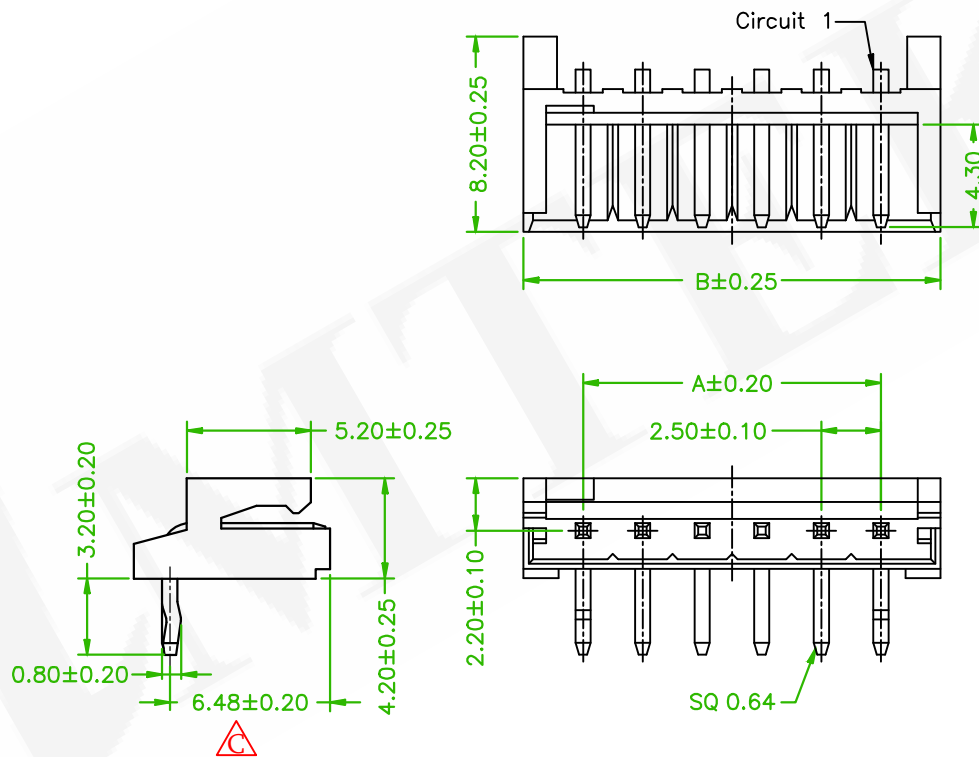

RECOMMENDED PCB LAYOUT
(PCB TOLERANCE ±0.05)

懌德精密有限公司
Amtek Technology Co., Ltd.
TEL: 886-2-2260-6878
FAX: 886-2-2260-8030

品名 TITLE	WAFER 2.5mm DIP R/A TYPE			頁數 Page	1/1
品號 PART NO.	5W2505R0-1XXXXXXLA01		繪圖 DRAWN	Roy	
圖號 DRAWING NO.	GW090-WW627	版本 REV.	C	核對 CHECKED	Owen
客戶品號 CUSTOMER P/N		比例 SCALE	None	承認 APPROVED	John
公差 TOLERANCE	.X±0.25 .XX±0.15	單位 UNIT	mm	THIRD ANGLE PROJECTION	

	ECN 202604059	Willy	2026/05/08
	Revise the drawing	Roy	2016/05/06
REV.	ECN NO. OR DESCRIPTION	REVISED	DATE