

**ORDER INFORMATION** B

**SPECIFICATION**

OPERATION TEMPERATURE: -40 °C TO +85 °C

**MATERIAL**

SFP CAGE: COPPER ALLOY  
EMI SPRING: COPPER ALLOY  
HEAT SINK: ALUMINUM ALLOY  
HEAT SINK CLIP: STAINLESS STEEL  
LIGHT PIPE: PC COLOR: CLEAR

5 H S P C 0 2 - 1 1 X X X X X - 0 2

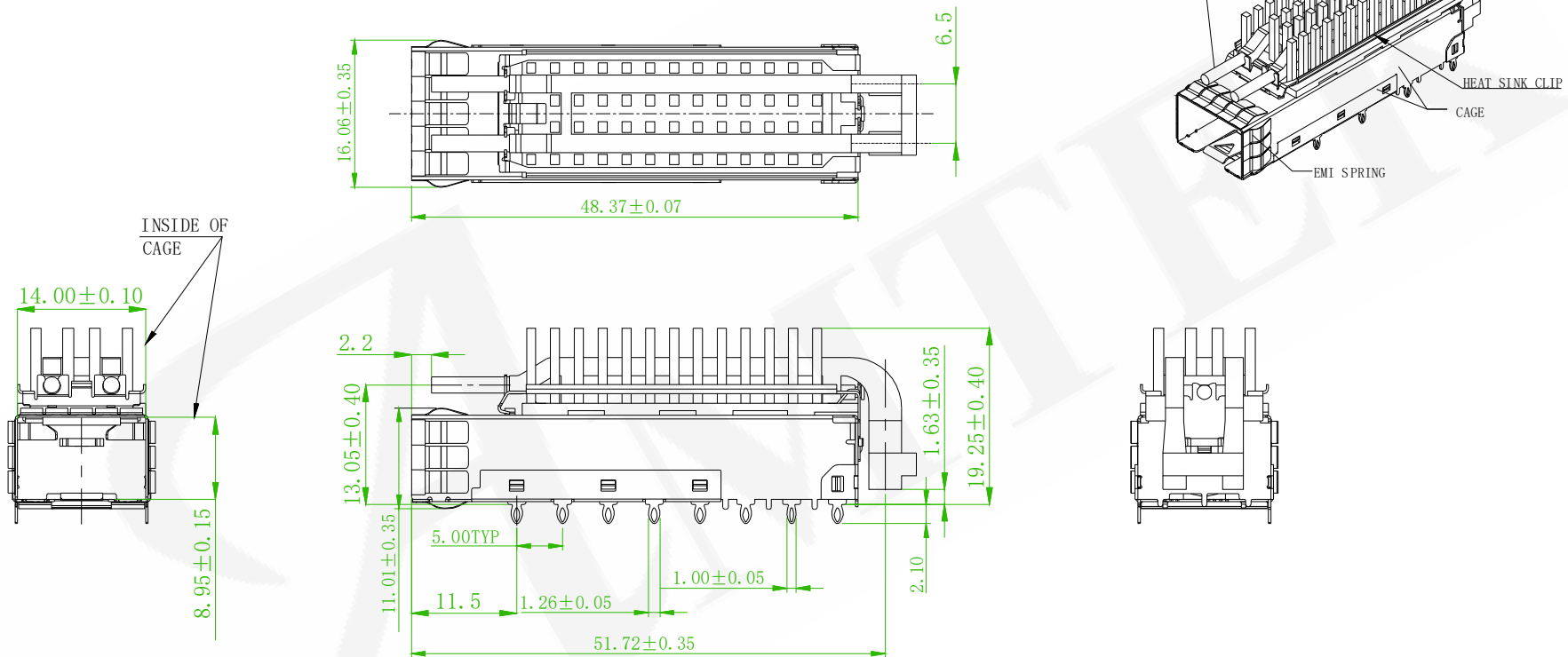
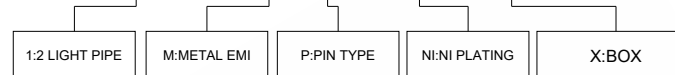

<span style="border: 1px solid black; padding: 2px;">B</span>	ECN-202602039	Roland	2026/04/21
REV.	ECN NO. OR DESCRIPTION	REVISED	DATE



**糧德精密有限公司**  
Amtek Technology Co., Ltd.

TEL: 886-2-2260-6878  
FAX: 886-2-2260-8030

品名 TITLE		SFP+ 1x1 CAGE WITH HEAT SINK (PRESS FIT)			頁數 Page	1/2
品號 PART NO.		<span style="border: 1px solid black; padding: 2px;">B</span> 5HSPC02-11XXXXXX-02		繪圖 DRAWN	Nick 2019/06/24	
圖號 DRAWING NO.		GN189-NI239	版本 REV.	B	核對 CHECKED	Josh 2019/06/24
客戶品號 CUSTOMER P/N			比例 SCALE	None	承認 APPROVED	Josh 2019/06/24
公差 TOLERANCE		.X ±0.25	單位 UNIT	mm	THIRD ANGLE PROJECTION	

SINGLE SIDED

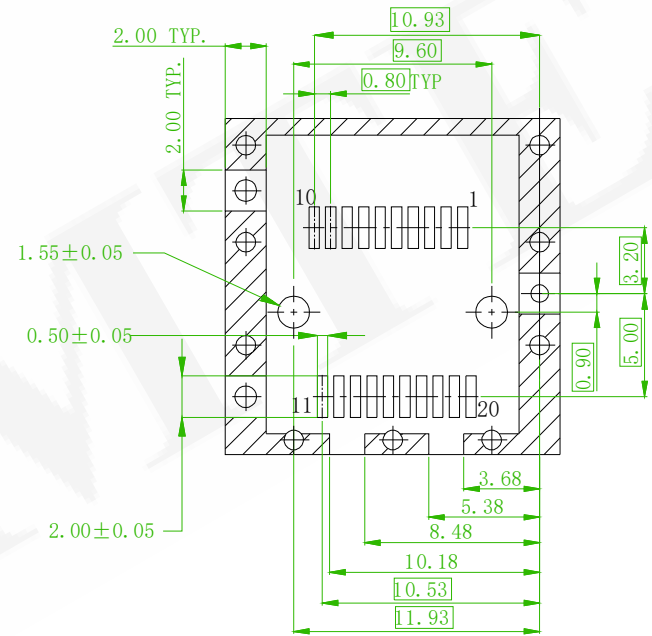
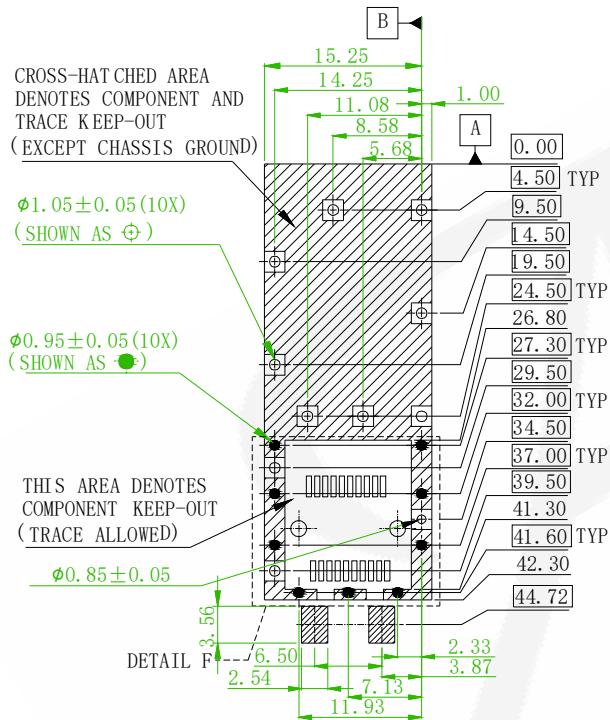
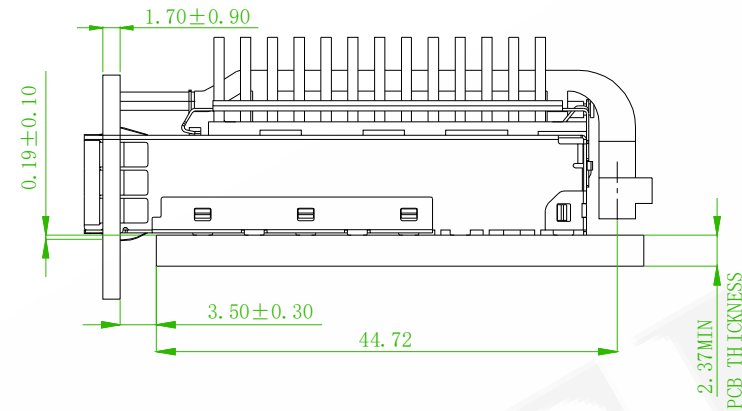
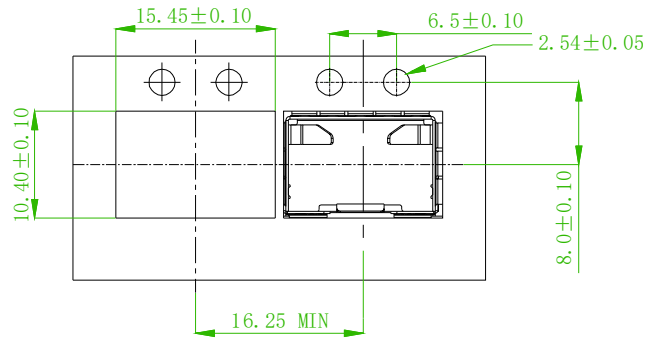

PCB LAYOUT (TOP VIEW)  
PCB TOLERANCES: +/-0.05

DETAIL F

REV.	ECN-202602039	Roland	2026/04/21
	ECN NO. OR DESCRIPTION	REVISED	DATE

懋德精密有限公司  
Amtek Technology Co., Ltd.  
TEL: 886-2-2260-6878  
FAX: 886-2-2260-8030

品名 TITLE	SFP+ 1x1 CAGE WITH HEAT SINK (PRESS FIT)			頁數 Page	2/2
品號 PART NO.	△ 5HSPC02-11XXXXXX-02		繪圖 DRAWN	Nick 2019/06/24	
圖號 DRAWING NO.	GN189-NI239	版本 REV.	B	核對 CHECKED	Josh 2019/06/24
客戶品號 CUSTOMER P/N		比例 SCALE	None	承認 APPROVED	Josh 2019/06/24
公差 TOLERANCE	.X ±0.25 .XX ±0.13	單位 UNIT	mm	THIRD ANGLE PROJECTION	