

SPECIFICATION

CURRENT RATE:0.5 AMP
 INSULATION RESISTANCE:100M Ω MIN.
 CONTACT RESISTANCE:30m Ω MAX.
 DIELECTRIC VOLTAGE:250V AC/MINUTE
 OPERATION TEMPERATURE:-25 ° C TO +85 ° C

MATERIAL

INSULATOR:HIGH TEMPERATURE THERMOPLASTIC,UL 94V-0
 ACTUATOR:HIGH TEMPERATURE THERMOPLASTIC,UL 94V-0
 CONTACT PIN:PHOSPHOR BRONZE
 HOLDDOWN:BRASS,TIN PLATED

ORDER INFORMATION

5 F P 3 A M S B D - X X X X X U X - 0 1

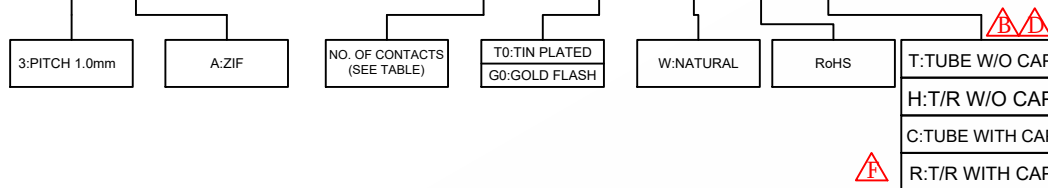

NO. OF CONTACTS	Dimension				NO. OF CONTACTS	Dimension			
	A	B	C	D		A	B	C	D
6	13.20	7.20	5.00	11.10	19	26.20	20.20	18.00	24.10
7	14.20	8.20	6.00	12.10	20	27.20	21.20	19.00	25.10
8	15.20	9.20	7.00	13.10	21	28.20	22.20	20.00	26.10
9	16.20	10.20	8.00	14.10	22	29.20	23.20	21.00	27.10
10	17.20	11.20	9.00	15.10	23	30.20	24.20	22.00	28.10
11	18.20	12.20	10.00	16.10	24	31.20	25.20	23.00	29.10
12	19.20	13.20	11.00	17.10	25	32.20	26.20	24.00	30.10
13	20.20	14.20	12.00	18.10	26	33.20	27.20	25.00	31.10
14	21.20	15.20	13.00	19.10	27	34.20	28.20	26.00	32.10
15	22.20	16.20	14.00	20.10	28	35.20	29.20	27.00	33.10
16	23.20	17.20	15.00	21.10	29	36.20	30.20	28.00	34.10
17	24.20	18.20	16.00	22.10	30	37.20	31.20	29.00	35.10
18	25.20	19.20	17.00	23.10					

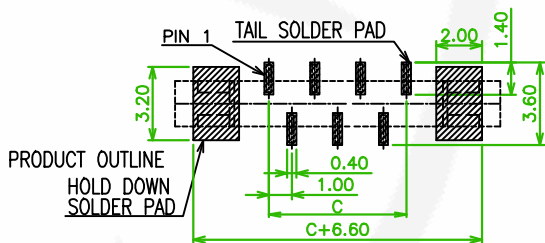
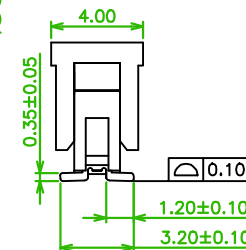
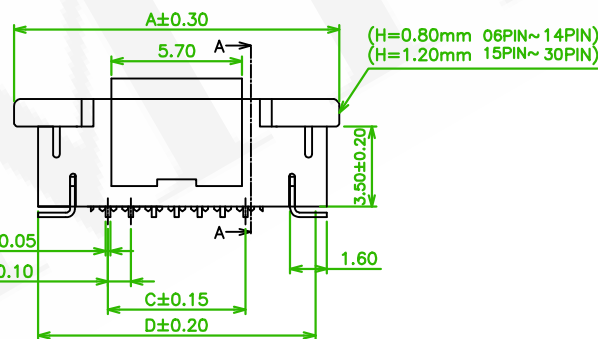
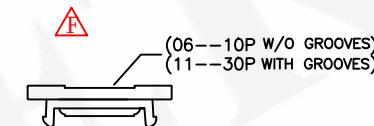
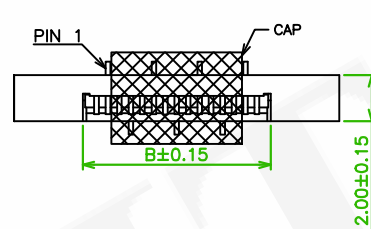
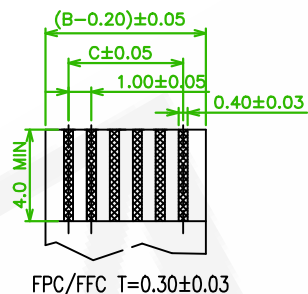

RECOMMENDED PCB LAYOUT
 (PCB TOLERANCE ±0.05)

△	ECN-202509074	Willy	2025/10/09
△x1	ECN-191207:Revise the with&w/o Cap of pin,Add the Table	Nick	2019/12/27
△x4	ECN NO.:181003,Revise the cap & Zif	Mia	2018/10/15
REV.	ECN NO. OR DESCRIPTION	REVISED	DATE

 糧德精密有限公司 Amtek Technology Co., Ltd. TEL: 886-2-2260-6878 FAX: 886-2-2260-8030	品名 TITLE	FPC CONNECOR 1.0mm SLIDER SMT V/T TYPE			頁數 Page	1/1
	品號 PART NO.	5FP3AMSD-XXXXUX-01			繪圖 DRAWN	Roy 2015/09/23
	圖號 DRAWING NO.	GN033-MD117	版本 REV.	F	核對 CHECKED	Josh 2018/10/15
	客戶品號 CUSTOMER P/N		比例 SCALE	None	承認 APPROVED	Jason 2018/10/15
	公差 TOLERANCE	.X ± 0.20 .XX ± 0.10	單位 UNIT	mm	THIRD ANGLE PROJECTION	