

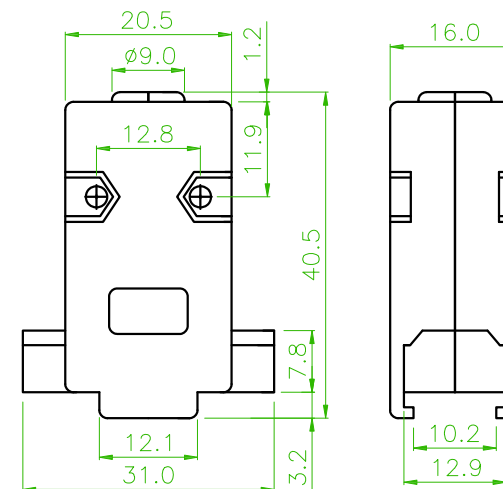

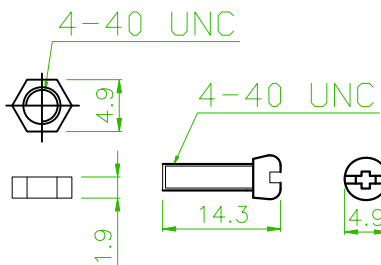

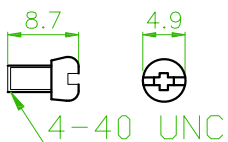
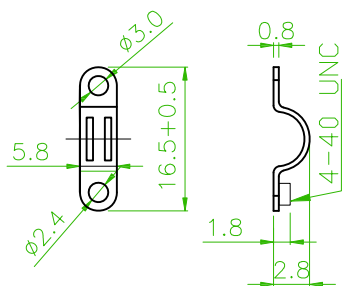
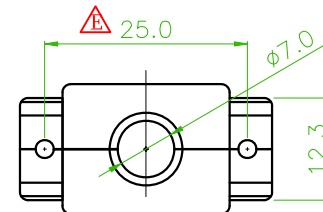
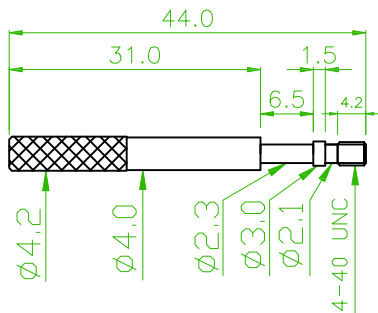
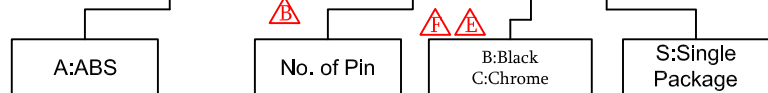

ORDER INFORMATION

 MATERIAL:
 INSULATOR : ABS UL94HB
 SCREW: STEEL
 FINISHED : CHROMATE PLATED

5 H D 1 0 2 A N - 0 9 X S A 1





Old P/N:HOOD102-XX-L

| | | | |
|--|--|---------|------------|
|  x1 | ECN NO.:191112, Add: Material | David | 2019/12/11 |
|  x1 | Revise the P/N:5HD102AN-XXSA1 -> 5HD102AN-09XSA1 | Eric | 2019/01/22 |
|  x1 | Revise the color: W:White -> W:Beige | Roy | 2018/10/02 |
|  x17 | ECN: 180715, revise dimensions, note. | Gary | 2018/08/17 |
|  x1 | Add the 37Pin | Mia | 2018/05/31 |
|  x13 | ECN NO.:180507,Revise the Dim. | Mia | 2018/05/24 |
| REV. | ECN NO. OR DESCRIPTION | REVISED | DATE |



糧德精密有限公司
 Amtek Technology Co., Ltd.
 TEL: 886-2-2260-6878
 FAX: 886-2-2260-8030

| | | | | | | |
|----------------------|---|-------------|-------------|----------------|------------------------|-----|
| 品名 TITLE | Hood 102 09P | | | | 頁數 Page | 1/4 |
| 品號 PART NO. |  5HD102AN-09XSA1  | | 繪圖 DRAWN | Roy | | |
| 圖號 DRAWING NO. | GW001-MD147 | 版本 REV. | H | 核對 CHECKED | Josh | |
| 客戶品號 CUSTOMER P/N | | 比例 SCALE | None | 承認 APPROVED | Josh | |
| 公差 TOLERANCE | .X ± 0.30 .XX ± 0.20 | .X° ± 1° | 單位 UNIT | mm | THIRD ANGLE PROJECTION | |