

ELECTRICAL

Voltage Rating: 300V
 Current Rating: 15A
 Contact Resistance: 20mΩ Max
 Insulation Resistance: 5000MΩ Min
 Withstanding Voltage: 1600V AC for one minute

ORDER INFORMATION

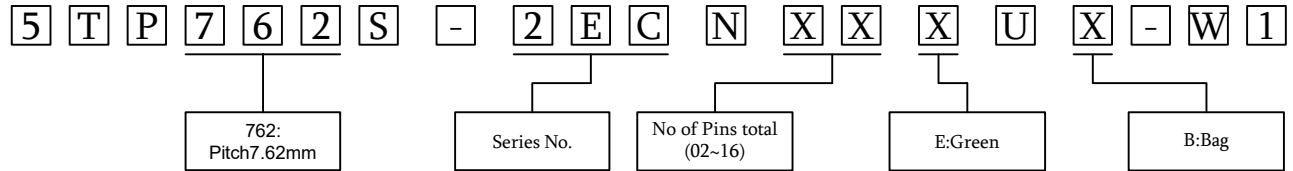

MECHANICAL



Operating Temperature: -40°C~+105°C
 Soldering Temperature: 245°C±10°C/5S

MATERIAL

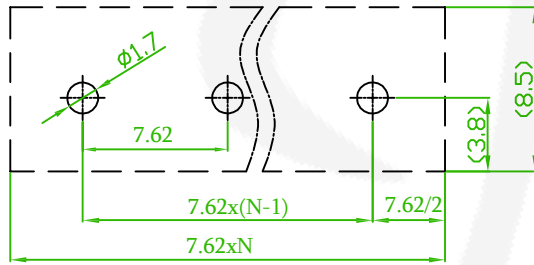
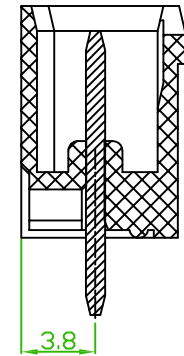
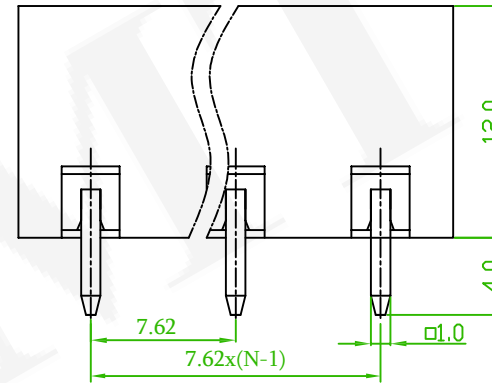
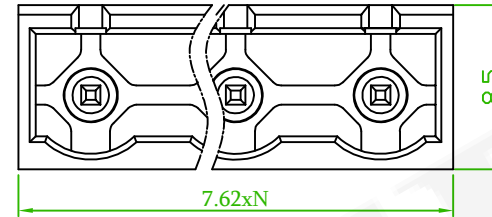
Insulator: Nylon9T, UL94V-0
 Solder pin: Brass, Tin plated



Recommended PCB Layout
 (PCB TOLERANCE ±0.05)

 禮德精密有限公司 Amtek Technology Co., Ltd. TEL: 886-2-2260-6878 FAX: 886-2-2260-8030	品名 TITLE	Terminal Block			頁數 Page	1/1	
	品號 PART NO.	5TP762S-2ECNXXXUX-W1		繪圖 DRAWN	Alice 2023/07/26		
	圖號 DRAWING NO.	GN005-GY095	版本 REV.	A	核對 CHECKED	Josh 2023/07/26	
	客戶品號 CUSTOMER P/N		比例 SCALE	None	承認 APPROVED	Josh 2023/07/26	
	公差 TOLERANCE	.X ±0.35 .XX ±0.25	單位 UNIT	mm	THIRD ANGLE PROJECTION		

REV.	ECN NO. OR DESCRIPTION	REVISED	DATE