

# ORDER INFORMATION

## ELECTRICAL

Standard: UL IEC  
 Rated Voltage: 300V 320V  
 Rated Current: 10A 10A  
 Withstanding Voltage: AC 1600V for one minute  
 Temp.Range:-40°C~+105°C

5 T P 5 0 0 S - 2 E C N X X X L B - 0 1

500:  
Pitch5.00mm

Series No.

No of Pins total  
(02~24)

G:Gray	O:Orange
U:Blue	R:Red
B:Black	T:Transparent
E:Green	N:Brown
	W:White

B:Bag

L:RoHS + Nylon66  
 Soldering Temperature:  
 200 / 230°C / 5~10 Sec  
 ☆Remark  
 Blank:Non RoHS





## MATERIAL

Housing: Nylon66, UL94V-0  
 Pin header:Copper alloy,Tin plated

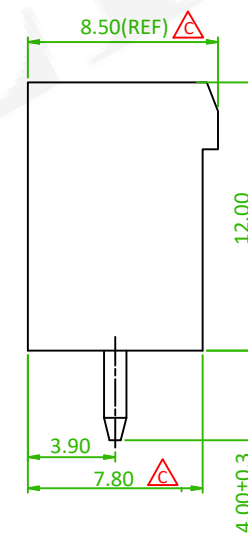
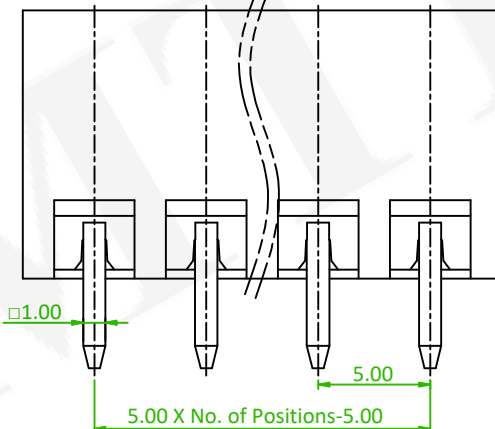
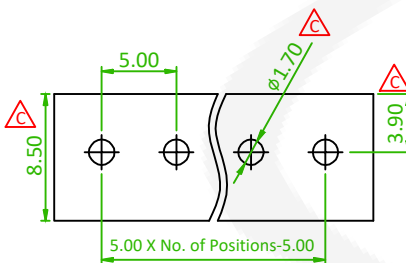
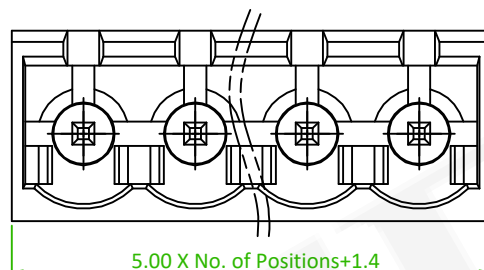

AMTEK 糧德  
 2022.10.03  
 Released DCC





linear dimension(Tolerances Standard GB/T 14486-2008)								—		
variable range	to 6	over 6 to 10	over 10 to 30	over 30 to 60	over 60 to 100	over 100 to 160	to 10	over 10 to 100	over 100 to 100	
tolerance	±0.20	±0.30	±0.50	±0.70	±1.00	±1.30	±1.60	0.10	0.30	0.60

Old Part No. :TB2EVC-5.0-XXP-1X-00A-L

 x1	ECN NO.:210508 Revise the Drawing	Alice	2022/07/12
 x6	ECN NO.:220417: Revise the Drawing	Alice	2022/05/10
 x1	ECN NO.:200718 Revise the Tolerance	Alice	2020/09/16
REV.	ECN NO. OR DESCRIPTION	REVISED	DATE



糧德精密有限公司  
 Amtek Technology Co., Ltd.  
 TEL: 886-2-2260-6878  
 FAX: 886-2-2260-8030

品名 TITLE	Terminal Block				頁數 Page	1/1
品號 PART NO.	5TP500S-2ECNXXXLB-01			繪圖 DRAWN	Mia 2016/12/21	
圖號 DRAWING NO.	GN011-MC159	版本 REV.	D	核對 CHECKED	Jonny 2016/12/21	
客戶品號 CUSTOMER P/N		比例 SCALE	None	承認 APPROVED	Aaron 2016/12/21	
公差 TOLERANCE		單位 UNIT	mm	THIRD ANGLE PROJECTION	