

**ELECTRICAL**

Standard: UL IEC  
 Rated Voltage: 300V 250V  
 Rated Current: 8A 10A  
 Contact Resistance: 20mΩ  
 Insulation Resistance: 500MΩ / DC 500V  
 Withstanding Voltage: AC 2000V for one min

**MECHANICAL**

Temp. Range: -40°C ~ +105°C  
 Soldering Max: +250°C 5s

**DIMENSIONS**

Pitch: 3.81mm  
 Poles: 2-24P

**MATERIAL**

Housing: PA66, UL94V-0  
 Clamp: Phosphor bronze, Tin plated

**ORDER INFORMATION** 

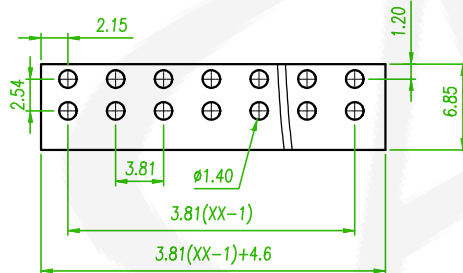
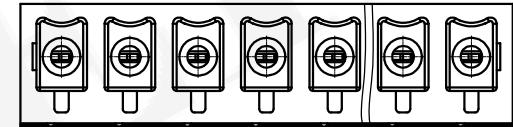
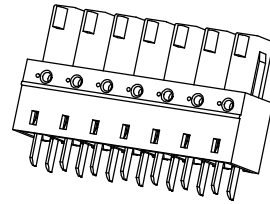
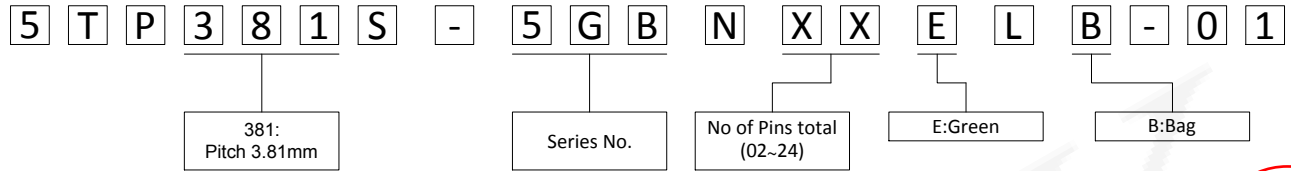

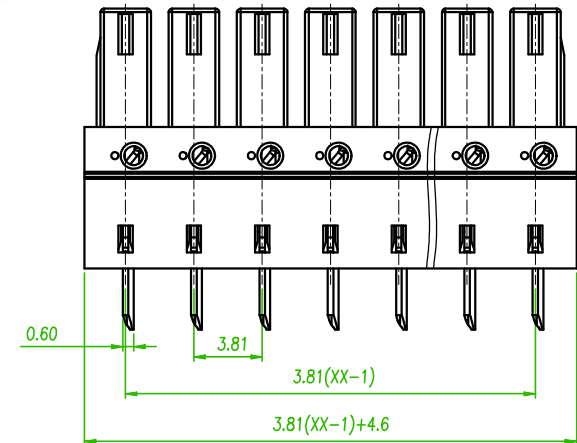
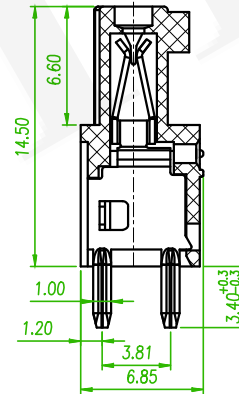

P.C.B. LAYOUT



linear dimension (Tolerances Standard GB/T 14486-2008)



variable range	to 6	over 6 to 10	over 10 to 30	over 30 to 60	over 60 to 100	over 100 to 160	to 10	over 10 to 100	to 100	
tolerance	±0.20	±0.30	±0.50	±0.70	±1.00	±1.30	±1.60	0.10	0.30	0.60

 x1	ECN NO.:200718 Revise the Tolerance	Alice	2020/09/10
	ECN NO.:170508 Revise the order information:5TP381S-5EBNXXELB-01->5TP381S-5GBNXXELB-01	B	2017/05/05 Mia
REV.	ECN NO. OR DESCRIPTION	REVISED	DATE



**糧德精密有限公司**  
 Amtek Technology Co., Ltd.  
 TEL: 886-2-2260-6878  
 FAX: 886-2-2260-8030

品名 TITLE	Terminal Block				頁數 Page	1/1
品號 PART NO.	 5TP381S-5GBNXXELB-01			繪圖 DRAWN	Roy 2016/02/16	
圖號 DRAWING NO.	GN011-MC388	版本 REV.	C	核對 CHECKED	Wanling 2016/02/16	
客戶品號 CUSTOMER P/N		比例 SCALE	None	承認 APPROVED	John 2016/02/16	
公差 TOLERANCE		單位 UNIT	mm	THIRD ANGLE PROJECTION	