



ORDER INFORMATION

Electrical

Standard: UL IEC
 Rated Voltage: 300V 250V
 Rated Current: 8A 7A 
 Contact Resistance: 20mΩ
 Insulation Resistance: 500MΩ / DC 500V
 Wire range: 28~16AWG 0.5~1.5mm² 
 Withstanding Voltage: AC 1600V for one minute 

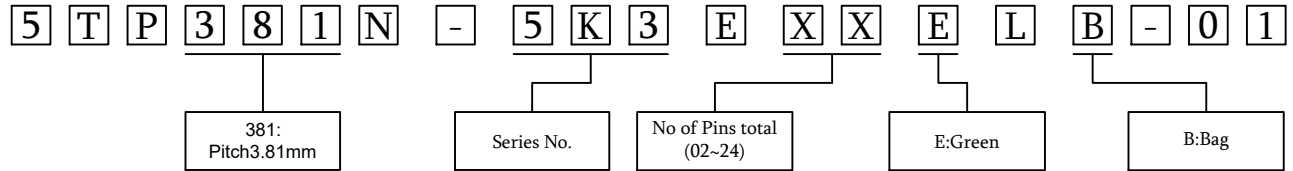

Mechanical

Torque: 0.2N-m (1.7Lb.in)
 Steip Length: 6-7mm
 Temp. Range: -40°C ~ +105°C

Dimensions

Pitch: 3.81mm
 Poles: 2-24P

Material

Housing: Nylon66, UL94V-0
 Screws: M2.0
 Contact: Copper Alloy, Ni plated 

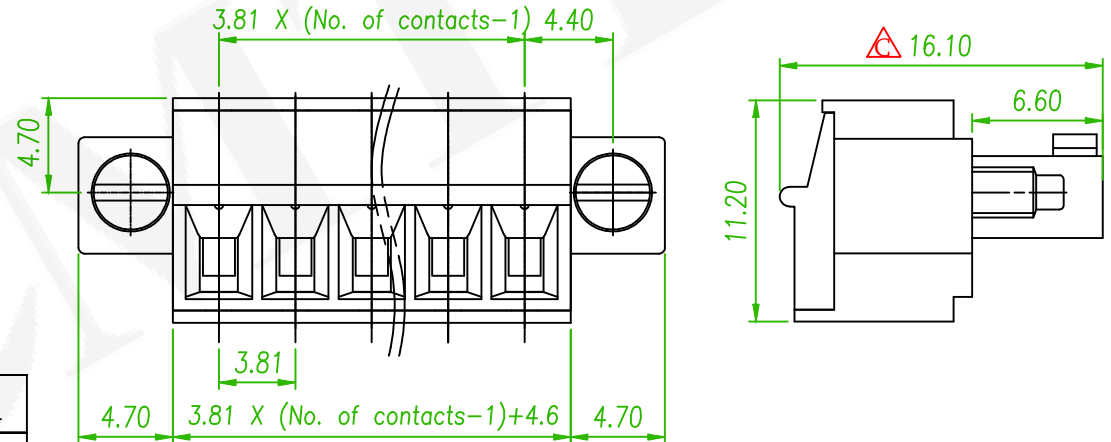
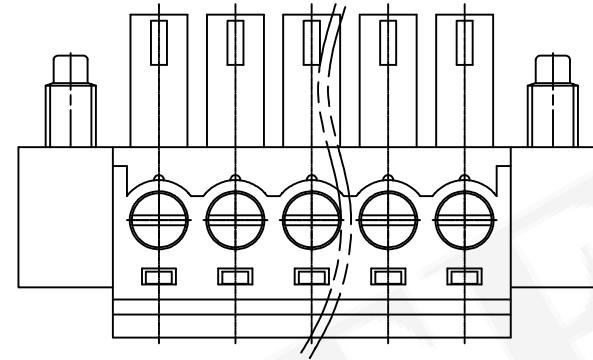



Old Part No. : TB15EKM-3.81



linear dimension (Tolerances Standard GB/T 14486-2008)



variable range	to 6	over 6 to 10	over 10 to 30	over 30 to 60	over 60 to 100	over 100 to 160	over 160 to 10	over 10 to 100	over 100 to 100	
tolerance	±0.20	±0.30	±0.50	±0.70	±1.00	±1.30	±1.60	0.10	0.30	0.60

 x5	QEC NO:220407 Revise the drawing	Alice	2022/04/27
 x1	ECN NO:200718 Revise the Dimension	Alice	2020/09/09
REV.	ECN NO. OR DESCRIPTION	REVISED	DATE



糧德精密有限公司
 Amtek Technology Co., Ltd.
 TEL: 886-2-2260-6878
 FAX: 886-2-2260-8030

品名 TITLE	Terminal Block				頁數 Page	1/1
品號 PART NO.	5TP381N-5K3EXXE L B-01			繪圖 DRAWN	Mia 2016/08/25	
圖號 DRAWING NO.	GN011-AL300	版本 REV.	C	核對 CHECKED	Jonny 2016/08/25	
客戶品號 CUSTOMER P/N		比例 SCALE	None	承認 APPROVED	Aaron 2016/08/25	
公差 TOLERANCE		單位 UNIT	mm	THIRD ANGLE PROJECTION	