

**ELECTRICAL** 

Standard: UL  
 Rated Voltage: 300V  
 Rated Current: 15A  
 Contact Resistance: 20mΩ  
 Withstanding Voltage: AC 2000V for one min  
 Insulation Resistance: 500MΩ  
 Wire range: 22-14AWG 1.5mm<sup>2</sup>

**MECHANICAL**

Temp. Range: -40°C ~ +105°C  
 Torque: 0.5Nm

**MATERIAL**

Housing: PA66, UL94V-0  
 Screws: M3.0 Steel Ni plated  
 Pin header: Copper alloy, Tin plated

**ORDER INFORMATION**

5 T B 7 6 2 S - 2 5 H E X X B L B - W 1

Series No. Poles (02-24P) B:Black B:Bag



AMTEK 耀德  
 2021.01.13  
 Released DCC

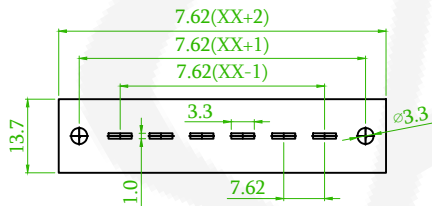
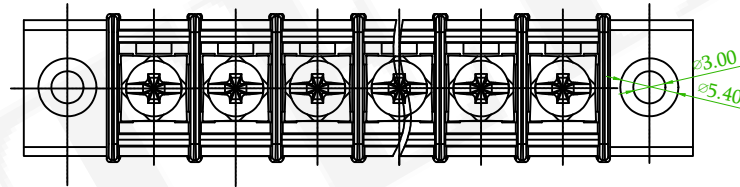

Recommended PCB Layout

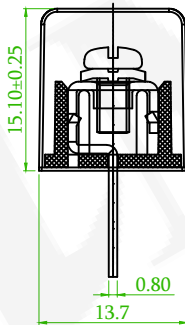

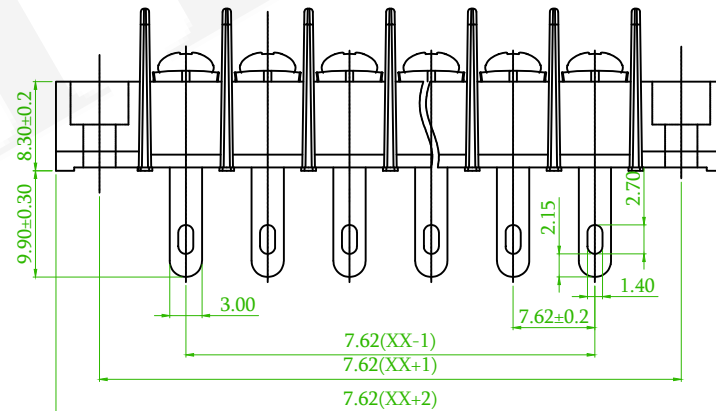

SECTION A-A



linear dimension (Tolerances Standard GB/T 14486-2008)



variable range	to 6	over 6 to 10	over 10 to 30	over 30 to 60	over 60 to 100	over 100 to 160	to 10	over 10 to 100	to 100	
tolerance	±0.20	±0.30	±0.50	±0.70	±1.00	±1.30	±1.60	0.10	0.30	0.60

 x2	ECN NO:201211 Revise the PART NO	Alice	2021/01/04
 x1	ECN NO:200718 Revise the Tolerance	Alice	2020/11/12
 x1	ECN 200102: Remove the IEC	David	2020/06/06
REV.	ECN NO. OR DESCRIPTION	REVISED	DATE



耀德精密有限公司  
 Amtek Technology Co., Ltd.  
 TEL: 886-2-2260-6878  
 FAX: 886-2-2260-8030

品名 TITLE	7.62mm Terminal Block				頁數 Page	1/1
品號 PART NO.	△5TB762S-25HEXXBLB-W1			繪圖 DRAWN	Eric 2019/01/10	
圖號 DRAWING NO.	GN011-EA533		版本 REV.	D	核對 CHECKED	Josh 2019/01/10
客戶品號 CUSTOMER P/N			比例 SCALE	None	承認 APPROVED	Jason 2019/01/10
公差 TOLERANCE			單位 UNIT	mm	THIRD ANGLE PROJECTION	