

Electrical 
 Standard: UL
 Rated Voltage: 300V
 Rated Current: 20A





Contact Resistance: 20mΩ
 Insulation Resistance: 500MΩ / DC 500V
 Wire Range: 22-12AWG 2.5mm²
 Dielectric Voltage: AC 2000V for one minute

Mechanical
 Temp. Range: -40°C ~ +105°C
 Torque: 1.2Nm

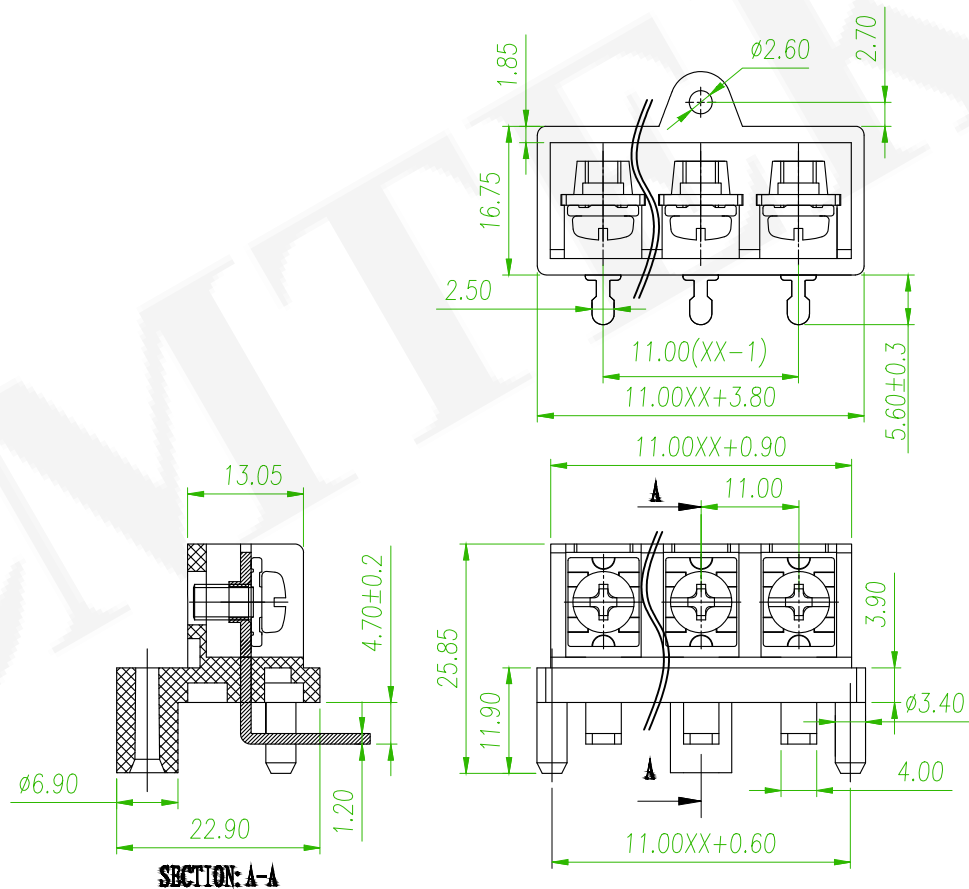
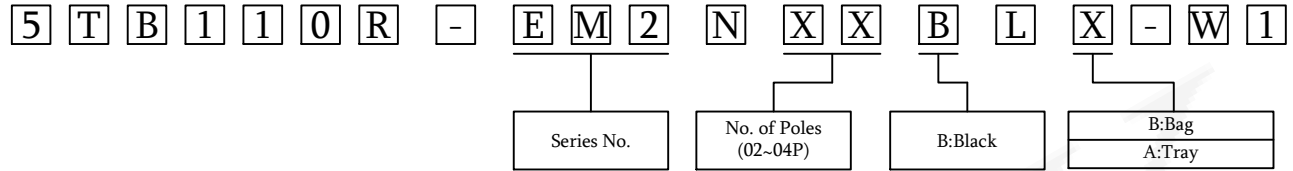
Material
 Housing: Nylon 66, UL94V-0
 Screws: M4.0, Steel, Gold Plated
 Pin Header: Brass, Gold Plated

ORDER INFORMATION



linear dimension (Tolerances Standard GB/T 14486-2008)								—		
variable range	to 6	over 6 to 10	over 10 to 30	over 30 to 60	over 60 to 100	over 100 to 160	over 160 to 10	over 10 to 100	over 100 to 100	
tolerance	±0.20	±0.30	±0.50	±0.70	±1.00	±1.30	±1.60	0.10	0.30	0.60
 x2	ECN NO:201211 Revise the PART NO.							Alice	2020/12/31	
 x1	ECN NO:200718 Revise the Tolerance							Alice	2020/11/09	
 x1	ECN 200102: Remove the IEC							David	2020/03/30	
REV.	ECN NO. OR DESCRIPTION							REVISED	DATE	



糧德精密有限公司
 Amtek Technology Co., Ltd.
 TEL: 886-2-2260-6878
 FAX: 886-2-2260-8030

品名 TITLE	11.0mm Terminal Block				頁數 Page	1/1
品號 PART NO.	 5TB110R-EM2NXXBLX-W1			繪圖 DRAWN	Roy 2018/12/27	
圖號 DRAWING NO.	GN011-R1076	版本 REV.	D	核對 CHECKED	Josh 2018/12/27	
客戶品號 CUSTOMER P/N		比例 SCALE	None	承認 APPROVED	Jason 2018/12/27	
公差 TOLERANCE		單位 UNIT	mm	THIRD ANGLE PROJECTION	