

MATERIAL

Insulator:Nylon 9T, UL94V-0, Black
Contact Pin:Brass

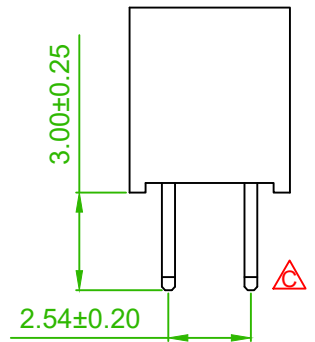
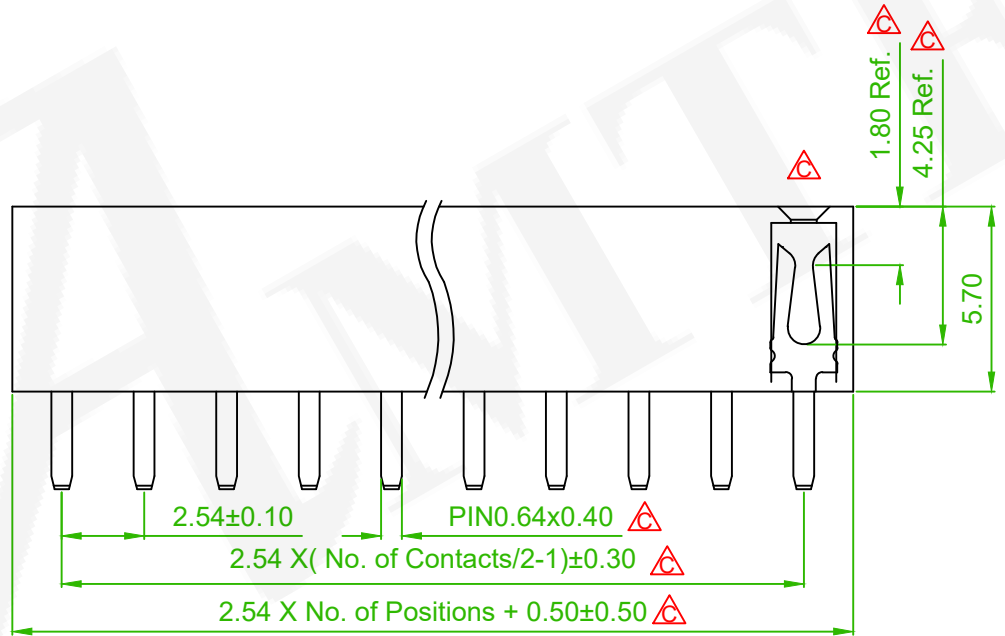
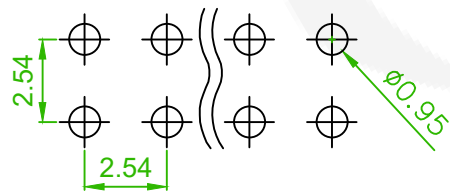
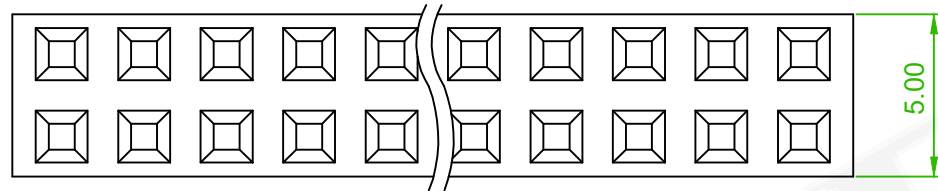
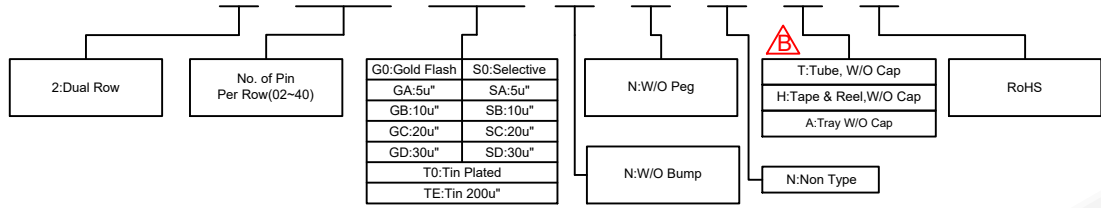

ORDER INFORMATION

5 P S 1 S D A 5 7 - 2 X X X X N N N X U - 0 0



 Recommended PCB Layout (PCB TOLERANCE ±0.05)

Old Part No. : PS1S57-2XX-U

 x1	ECN NO.:220102 Revise the drawing	Alice	2022/05/04
 x8	ECN No:210417 Revise the drawing	Alice	2021/05/07
 x1	Add The Packing:Tray	Kilin	2017/09/21
REV.	ECN NO. OR DESCRIPTION	REVISED	DATE



糧德精密有限公司
Amtek Technology Co., Ltd.
TEL: 886-2-2260-6878
FAX: 886-2-2260-8030

品名 TITLE	FEMALE HEADER 2.54mm			頁數 Page	1/1
品號 PART NO.	5PS1SDA57-2XXXXNNNXU-00			繪圖 DRAWN	Jeff 2016/11/16
圖號 DRAWING NO.	GN003-KL071	版本 REV.	D	核對 CHECKED	John 2016/11/16
客戶品號 CUSTOMER P/N		比例 SCALE	None	承認 APPROVED	John 2016/11/16
公差 TOLERANCE	.X ± 0.38	單位 UNIT	mm	THIRD ANGLE PROJECTION	
	.XX ± 0.25				