

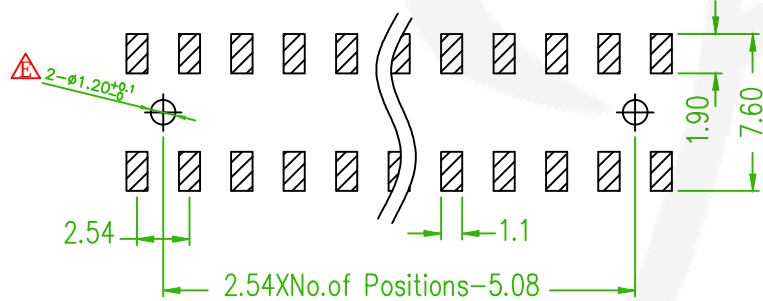

ORDER INFORMATION

MATERIAL

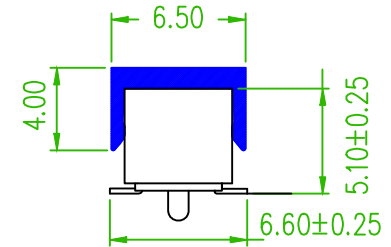
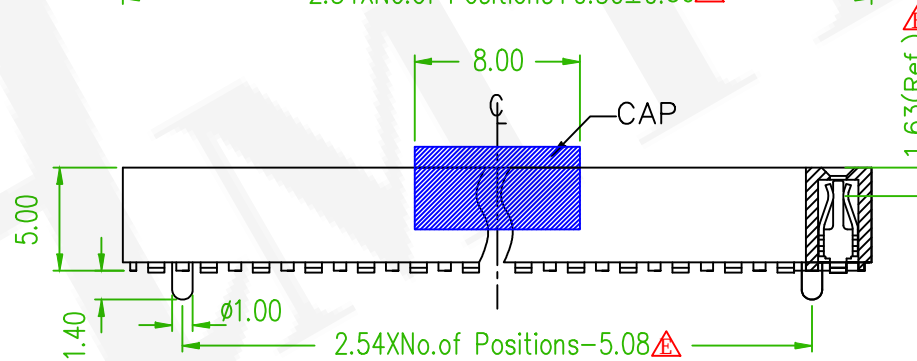
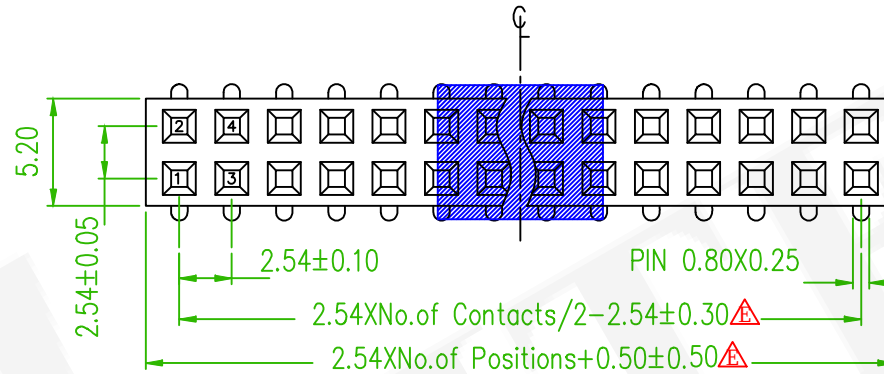
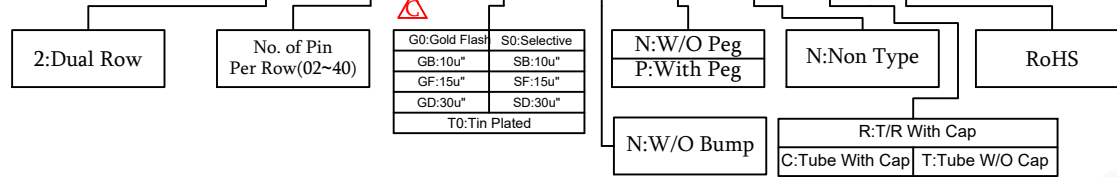

Insulator:Nylon 9T, UL94V-0, Black
Contact Pin:Phosphor Bronze



5 P S 1 M S A 5 0 - 2 X X X X N X N X U - 0 0



Recommended PCB Layout
(PCB TOLERANCE ±0.05) 

Old Part No. : PS1M50-2XX-U

 糧德精密有限公司 Amtek Technology Co., Ltd. TEL: 886-2-2260-6878 FAX: 886-2-2260-8030	品名 TITLE	FEMALE HEADER 2.54mm			頁數 Page	1/1
	品號 PART NO.	5PS1MSA50-2XXXXNXNXU-00			繪圖 DRAWN	Athena 2015/08/31
	圖號 DRAWING NO.	GN003-RL535	版本 REV.	F	核對 CHECKED	John 2015/08/31
	客戶品號 CUSTOMER P/N		比例 SCALE	None	承認 APPROVED	John 2015/08/31
	公差 TOLERANCE	.X ±0.38 .XX ±0.25	單位 UNIT	mm	THIRD ANGLE PROJECTION	

	ECN NO.:220102 Revise the drawing	Alice	2022/03/31
	ECN NO.:210807 Revise the Drawing	Benson	2021/08/31
	Add the Recommended Mating Part	Eric	2019/01/28
REV.	ECN NO. OR DESCRIPTION	REVISED	DATE