

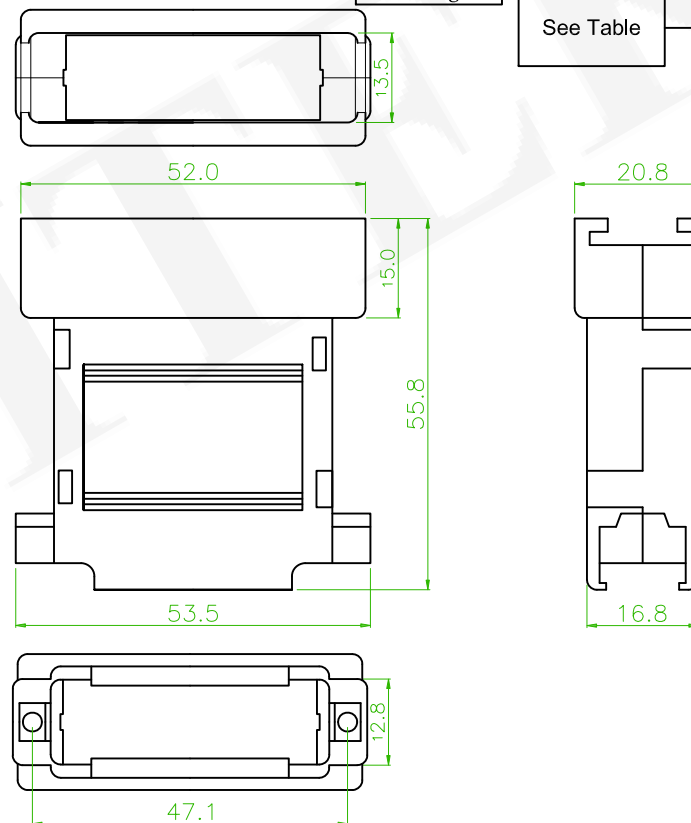

SPECIFICATION 
 INSULATOR : ABS UL94HB
 SCREW: STEEL
 FINISHED : CHROMATE PLATED

ORDER INFORMATION

5 H D 3 2 0 A N - C 2 X S A X

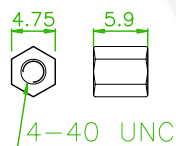
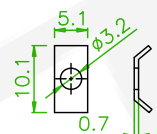
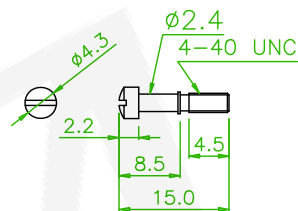
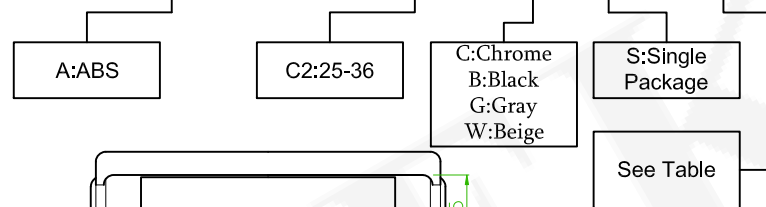

Part No.	SCREW	NUT	Washer
5HD320AN-C2XSA1	2	0	2
5HD320AN-C2XSA2	2	2	2

REV.	ECN NO. OR DESCRIPTION	REVISED	DATE
 x1	ECN NO.: 191112 Add the spec	Benson	2019/12/16

 糧德精密有限公司 Amtek Technology Co., Ltd. TEL: 886-2-2260-6878 FAX: 886-2-2260-8030	品名 TITLE	HOOD 320 25-36P				頁數 Page	1/1
	品號 PART NO.	5HD320AN-C2XSAX			繪圖 DRAWN	Roy	
	圖號 DRAWING NO.	GW001-R1175	版本 REV.	B	核對 CHECKED	Josh	
	客戶品號 CUSTOMER P/N		比例 SCALE	None	承認 APPROVED	Josh	
	公差 TOLERANCE	.X ± 0.30 .XX ± 0.20	.X° ± 5°	單位 UNIT	mm	THIRD ANGLE PROJECTION	