

NOTE: 
 MATERIAL: zinc alloy
 SCREW: STEEL
 FINISHED: Nickel plated

ORDER INFORMATION

5 H D 1 1 7 Z R - 0 9 N S A X



AMTEK 糧德
 2019.12.13
 Released DCC

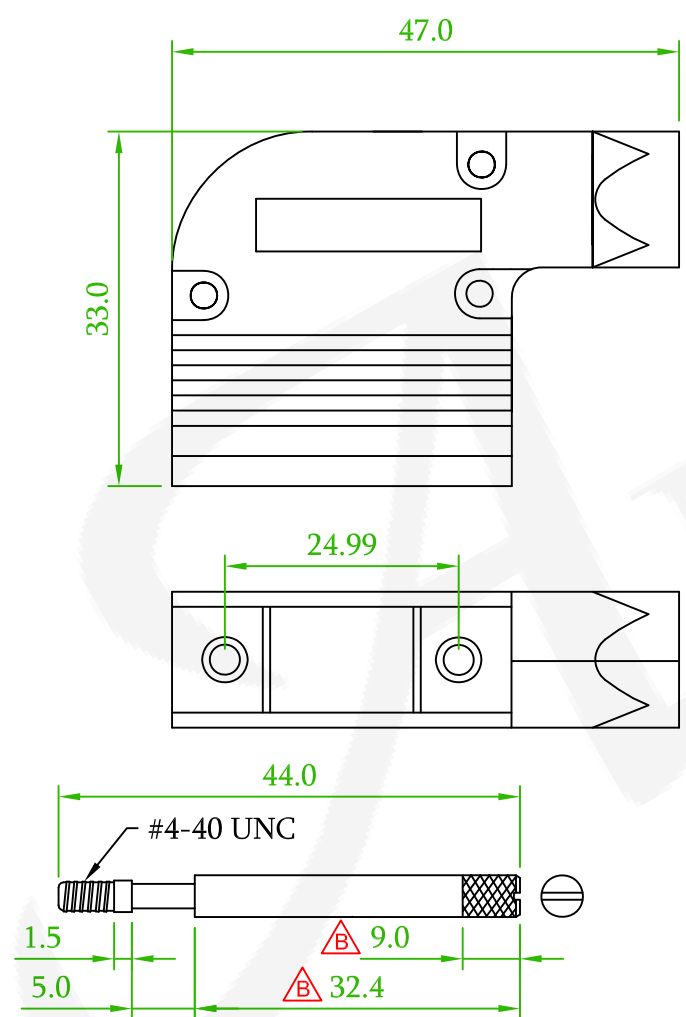

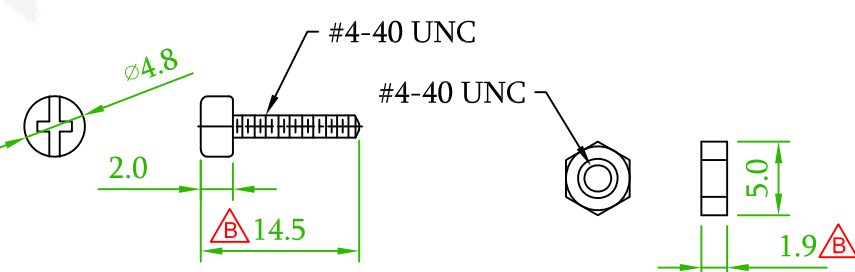
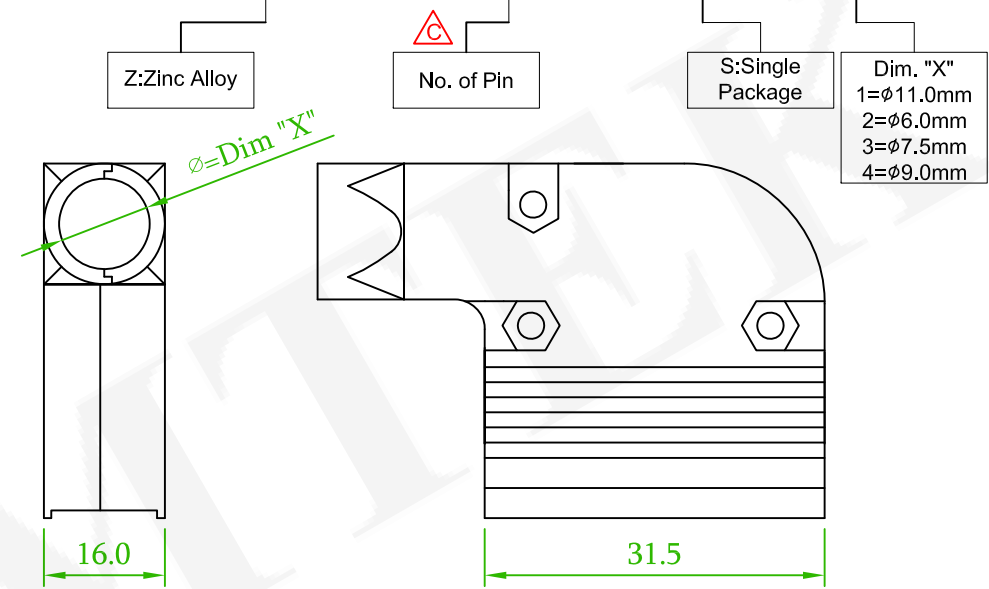

Long Bolt



Short Screw

Nut

Old P/N:HOOD117-XXDTYX-L

 x1	ECN-191112 Add the SPEC	Nick	2019/12/12
 x1	Remove options, note.	Gary	2019/01/22
 x9	ECN NO.: 180713, revise dimensions.	Gary	2018/08/14
REV.	ECN NO. OR DESCRIPTION	REVISED	DATE

 糧德精密有限公司 Amtek Technology Co., Ltd. TEL: 886-2-2260-6878 FAX: 886-2-2260-8030	品名 TITLE	HOOD117 Series 09 Pin				頁數 Page	1/1
	品號 PART NO.	5HD117ZR-09NSAX				繪圖 DRAWN	Gary 2017/04/25
	圖號 DRAWING NO.	GW001-GA391	版本 REV.	D	核對 CHECKED	Josh 2019/01/22	
	客戶品號 CUSTOMER P/N		比例 SCALE	None	承認 APPROVED	Josh 2019/01/22	
	公差 TOLERANCE	.X ± 0.30 .XX ± 0.20	單位 UNIT	mm	THIRD ANGLE PROJECTION	