

MATERIAL: 

INSULATOR:ABS ,UL94HB



SCREW:STEEL NICKEL PLATED 

ORDER INFORMATION

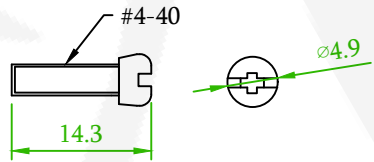
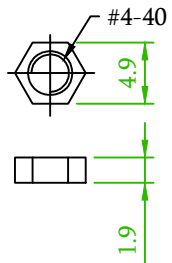
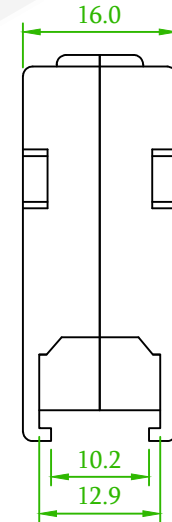
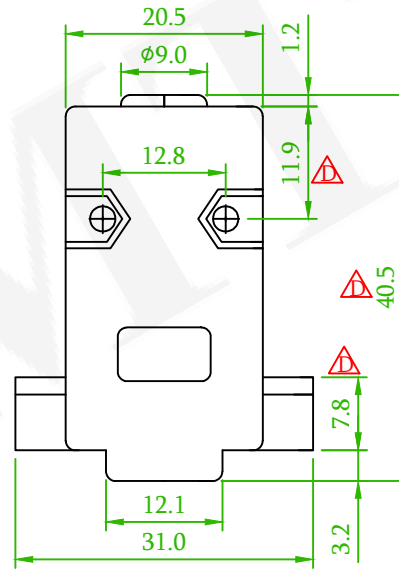
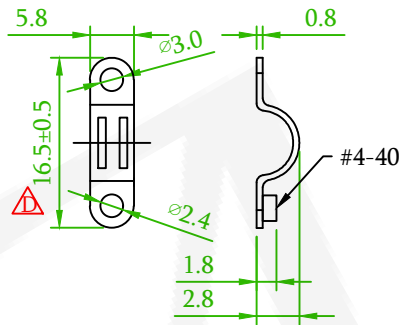
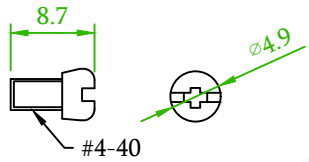
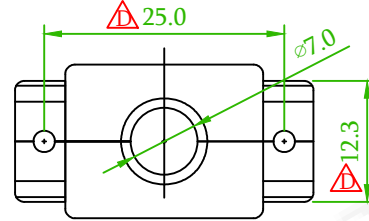
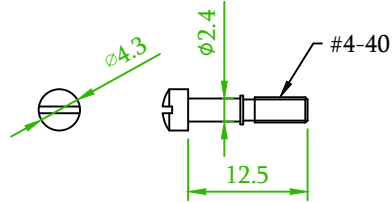
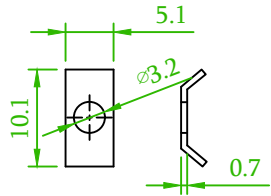
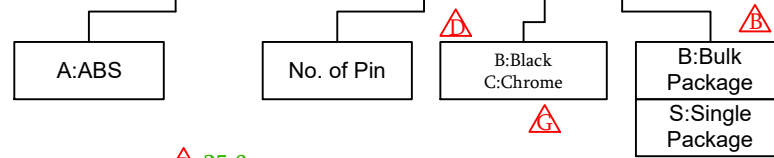
5 H D 1 0 1 A N - 0 9 X X A 1





 Old P/N: H00D101-XXXXY-L

| | | | |
|--|---|---------|------------|
|  x1 | ECN NO.:221226 Revise the material | Alice | 2022/12/27 |
|  x1 | ECN NO.:191112, Add: Material | David | 2019/12/10 |
|  x1 | Revise the P/N :5HD101AN-XXXXA1 -> 5HD101AN-09XXA1, and color | Eric | 2019/01/22 |
| REV. | ECN NO. OR DESCRIPTION | REVISED | DATE |



糧德精密有限公司
Amtek Technology Co., Ltd.
TEL: 886-2-2260-6878
FAX: 886-2-2260-8030

| | | | | | | |
|----------------------|---|-------------|-------------|------------------------------|---|-----|
| 品名 TITLE | Hood 101 09P | | | | 頁數 Page | 1/4 |
| 品號 PART NO. |  5HD101AN-09XXA1 | | 繪圖 DRAWN | Roy | | |
| 圖號 DRAWING NO. | GW001-MC439 | 版本 REV. | I | 核對 CHECKED | Josh | |
| 客戶品號 CUSTOMER P/N | | 比例 SCALE | None | 承認 APPROVED | Josh | |
| 公差 TOLERANCE | .X ± 0.30 | 單位 UNIT | mm | THIRD ANGLE PROJECTION |  | |