

MATERIAL

Contact Pin:Brass

NOTE

- 1.THE BEST USE TIME OF TIN PLATING PARTS ARE WITHIN 3 MONTHS SINCE MFG DATE.
- 2.FINISH:TIN PLATED. IF PARTS ARE NOT USED UP PLEASE STORE IN A SEAL BAG.
- 3.LOAD CURRENT:45A.

ORDER INFORMATION

5 G B M - 0 2 5 X X - A 1

◎:Standard Recommend

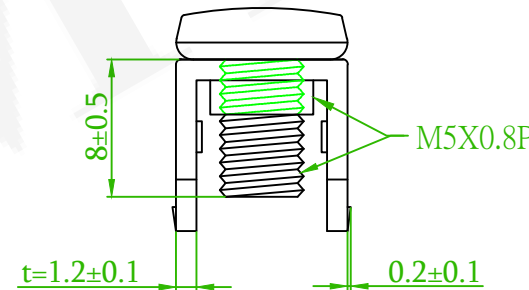
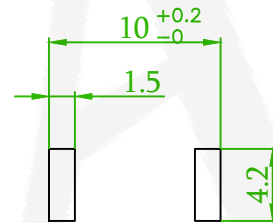
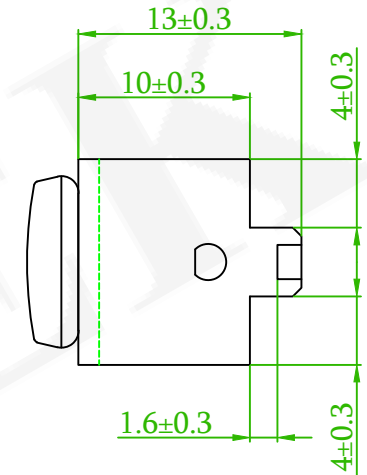
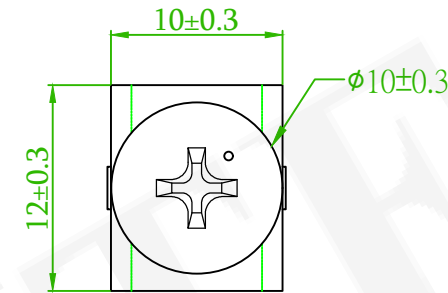
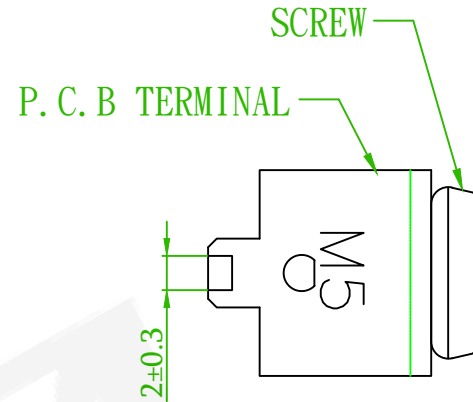

T0:Tin Plated
◎TM:Matte Tin



MOUNTING HOLE
P.C.B THICKNESS 1.6~2.0

(RoHS Compliant)

★ Pb	<1000PPM
★ Cd	< 100PPM
★ Hg	<1000PPM
★ Cr6+	<1000PPM
★ PBBs	<1000PPM
★ PBDEs	<1000PPM

 糧德精密有限公司 Amtek Technology Co., Ltd. TEL: 886-2-2260-6878 FAX: 886-2-2260-8030	品名 TITLE	P.C.B TERMINAL				頁數 Page	1/1
	品號 PART NO.	5GBM-025XX-A1			繪圖 DRAWN	Nick 2019/12/31	
	圖號 DRAWING NO.	GW018-NI725	版本 REV.	B	核對 CHECKED	Josh 2019/12/31	
	客戶品號 CUSTOMER P/N		比例 SCALE	None	承認 APPROVED	Josh 2019/12/31	
	公差 TOLERANCE		單位 UNIT	mm	THIRD ANGLE PROJECTION		

QEC NO.:231104 Revise the Plating Options

Gaby 2023/11/27

REV. ECN NO. OR DESCRIPTION

REVISED DATE