

SPECIFICATION

Current Rate:0.5 AMP
 Insulation Resistance:100M Ω Min.
 Contact Resistance:30m Ω Max.
 Dielectric Voltage:250V AC/Minute
 Operation Temperature:-20 °C to +85 °C

MATERIAL

Insulator:High Temperature Thermoplastic,UL 94V-0
 Contact Pin:Copper Alloy

ORDER INFORMATION

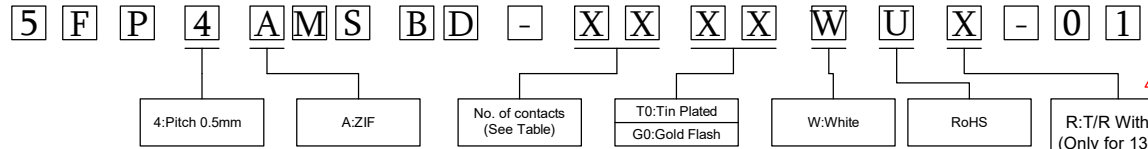

⚠ CAP not available under 12P included, if need pick and place function, please refer P/N: 5FP4AMSBD-XXXXWUH-02

PIN	Dimension				PIN	Dimension				PIN	Dimension			
	A	B	C	D		A	B	C	D		A	B	C	D
3	8.2	2.2	1.0	6.1	23	18.2	12.2	11.0	16.1	43	28.2	22.2	21.0	26.1
4	8.7	2.7	1.5	6.6	24	18.7	12.7	11.5	16.6	44	28.7	22.7	21.5	26.6
5	9.2	3.2	2.0	7.1	25	19.2	13.2	12.0	17.1	45	29.2	23.2	22.0	27.1
6	9.7	3.7	2.5	7.6	26	19.7	13.7	12.5	17.6	46	29.7	23.7	22.5	27.6
7	10.2	4.2	3.0	8.1	27	20.2	14.2	13.0	18.1	47	30.2	24.2	23.0	28.1
8	10.7	4.7	3.5	8.6	28	20.7	14.7	13.5	18.6	48	30.7	24.7	23.5	28.6
9	11.2	5.2	4.0	9.1	29	21.2	15.2	14.0	19.1	49	31.2	25.2	24.0	29.1
10	11.7	5.7	4.5	9.6	30	21.7	15.7	14.5	19.6	50	31.7	25.7	24.5	29.6
11	12.2	6.2	5.0	10.1	31	22.2	16.2	15.0	20.1	51	32.2	26.2	25.0	30.1
12	12.7	6.7	5.5	10.6	32	22.7	16.7	15.5	20.6	52	32.7	26.7	25.5	30.6
13	13.2	7.2	6.0	11.1	33	23.2	17.2	16.0	21.1	53	33.2	27.2	26.0	31.1
14	13.7	7.7	6.5	11.6	34	23.7	17.7	16.5	21.6	54	33.7	27.7	26.5	31.6
15	14.2	8.2	7.0	12.1	35	24.2	18.2	17.0	22.1	55	34.2	28.2	27.0	32.1
16	14.7	8.7	7.5	12.6	36	24.7	18.7	17.5	22.6	56	34.7	28.7	27.5	32.6
17	15.2	9.2	8.0	13.1	37	25.2	19.2	18.0	23.1	57	35.2	29.2	28.0	33.1
18	15.7	9.7	8.5	13.6	38	25.7	19.7	18.5	23.6	58	35.7	29.7	28.5	33.6
19	16.2	10.2	9.0	14.1	39	26.2	20.2	19.0	24.1	59	36.2	30.2	29.0	34.1
20	16.7	10.7	9.5	14.6	40	26.7	20.7	19.5	24.6	60	36.7	30.7	29.5	34.6
21	17.2	11.2	10.0	15.1	41	27.2	21.2	20.0	25.1	61	37.2	31.2	30.0	35.1
22	17.7	11.7	10.5	15.6	42	27.7	21.7	20.5	25.6					

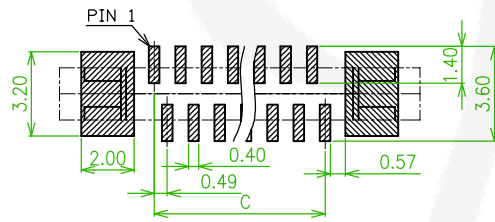

RECOMMENDED PCB LAYOUT

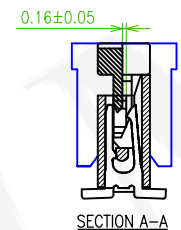

SECTION A-A

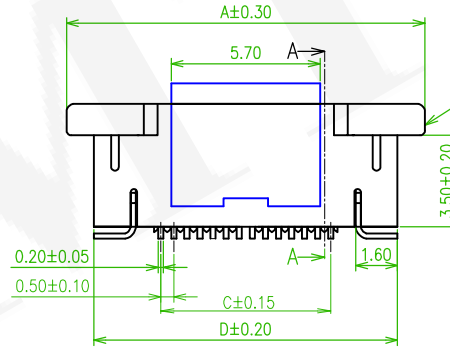
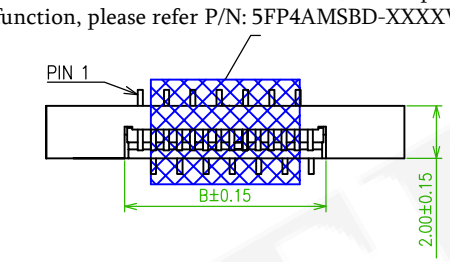

(H=0.80mm PIN ≤30PIN)
 (H=1.20mm PIN ≥31PIN)

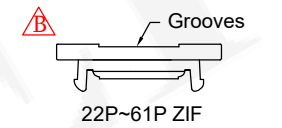
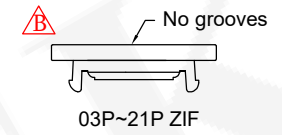
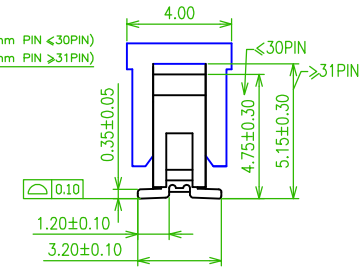

SCALE 1:2

Old Part No. : FPC4AMS6-XX-B-U

Amtek Technology Co., Ltd.
 TEL: 886-2-2260-6878
 FAX: 886-2-2260-8030

品名 TITLE	FPC/FFC 0.5mm Zif Straight SMT Type				頁數 Page	1/1
品號 PART NO.	5FP4AMSBD-XXXXWUX-01			繪圖 DRAWN	Roy 2015/09/24	
圖號 DRAWING NO.	GN033-BN893	版本 REV.	B	核對 CHECKED	John 2015/09/24	
客戶品號 CUSTOMER P/N		比例 SCALE	None	承認 APPROVED	John 2015/09/24	
公差 TOLERANCE	.X ± 0.20	.X°±3	單位 UNIT	mm	THIRD ANGLE PROJECTION	

△x4	ECN NO.:211221 Revise the Package	Benson	2022/01/14
REV.	ECN NO. OR DESCRIPTION	REVISED	DATE