

SPECIFICATIONS

Current Rating: 3 AMP
 Insulation Resistance: 1000MΩ Min.
 Contact Resistance: 20mΩ Max.
 Dielectric Voltage: 1000V AC for one minute
 Operation Temperature: -55°C to +105°C

MATERIAL

Insulator: PBT+G.F., UL94V-0
 Contact Pin: Copper Alloy

ORDER INFORMATION

5 7 D B D S X M - X X X X X A - A 1



1: Tin shell + L(RoHS)
 2: Nickel shell + L(RoHS)

M: Male
 No. of contacts

Boardlock	Mounting
NN	W/O
NA	W/O
NC	W/O
NO	W/O
BA	With
BB	With
BO	With
CC	With

G0: Gold Flash	S0: Selective
GA: 5u"	SA: 5u"
GB: 10u"	SB: 10u"
GC: 20u"	SC: 20u"
GD: 30u"	SD: 30u"
TO: Tin Plated	
TE: Tin 200u"	

W: Natural
 B: Black
 U: Blue
 A: Tray

⊙: Standard Recommend



Dimensions

No. of Contacts	A	B	C	D
09	30.81	24.99	16.92	11.08
15	39.20	33.30	25.25	19.39
25	53.05	47.04	38.96	33.24
37	69.40	63.50	55.42	49.86

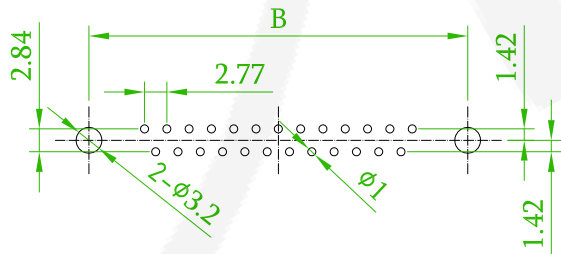
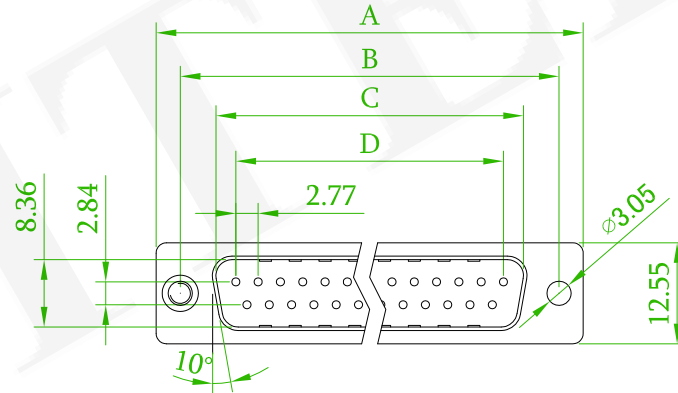

Recommended PCB Layout
 (PCB TOLERANCE ±0.1)

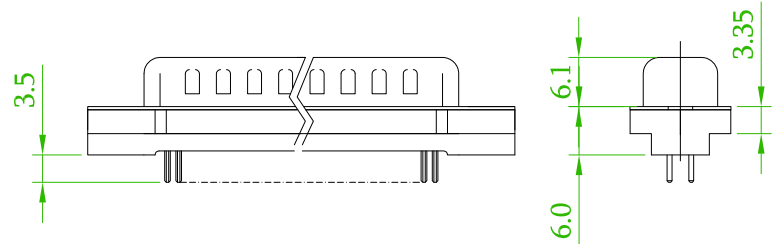

Old Part No.: DBDA-MXX-L

REV.	ECN NO. OR DESCRIPTION	REVISED	DATE
△x3	Add codes of accessories: O: Thread Insert M3.	Gary	2018/05/31
△x4	ECN NO.: 171005, revise codes of accessories.	Gary	2017/11/22

<p>Amtek Technology Co., Ltd. TEL: 886-2-2268-8036 FAX: 886-2-2268-8035</p>	品名 TITLE	D-SUB V/T DIP TYPE			頁數 Page	1/2
	品號 PART NO.	57DBDSXM-XXXXXXXXA-A1			繪圖 DRAWN	Jeff
	圖號 DRAWING NO.	GW006-GA787	版本 REV.	C	核對 CHECKED	Josh
	客戶品號 CUSTOMER P/N		比例 SCALE	None	承認 APPROVED	Jason
	公差 TOLERANCE	.X ±0.25 .XX ±0.13	單位 UNIT	mm	THIRD ANGLE PROJECTION	

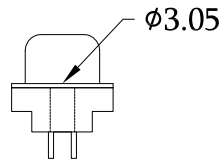

57DBDSXM-XXNNXXXXA-A1
 Ø3.05 Clear Hole

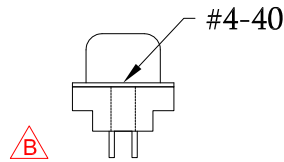

57DBDSXM-XXNAXXXA-A1
 Thread Insert #4-40

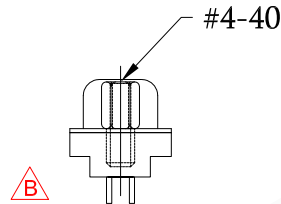

57DBDSXM-XXNCXXXXA-A1
 Thread Insert #4-40
 +Jack Screw #4-40 Removable

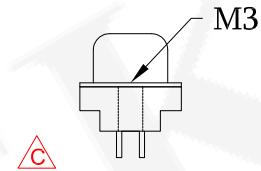

57DBDSXM-XXNAXXXA-A1
 Thread Insert M3

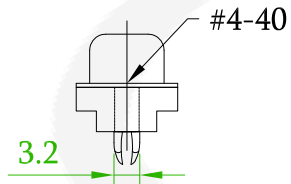

57DBDSXM-XXBAXXXA-A1
 With Boardlock
 Thread Insert #4-40

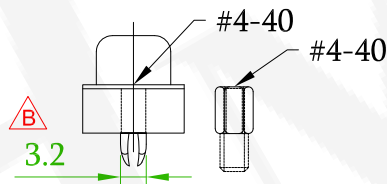

57DBDSXM-XXBBXXXXA-A1
 With Boardlock
 Thread Insert #4-40
 +Jack Screw #4-40 Attached

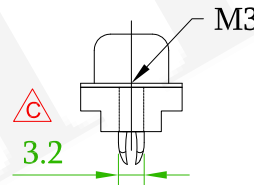

57DBDSXM-XXBOXXXA-A1
 With Boardlock
 Thread Insert M3

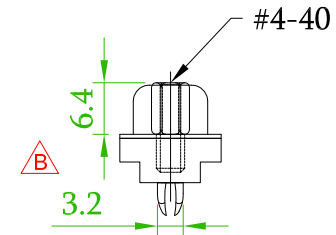

57DBDSXM-XXCCXXXXA-A1
 With Boardlock
 Thread Insert #4-40
 +Jack Screw #4-40 Removable

Old Part No.:DBDA-MXX-L

REV.	ECN NO. OR DESCRIPTION	REVISED	DATE
C x4	Add codes of accessories: O: Thread Insert M3.	Gary	2018/05/31
B x4	ECN NO.: 171005, revise codes of accessories.	Gary	2017/11/22

<p>Amtek Technology Co., Ltd. TEL: 886-2-2268-8036 FAX: 886-2-2268-8035</p>	品名 TITLE	D-SUB V/T DIP TYPE			頁數 Page	2/2
	品號 PART NO.	57DBDSXM-XXXXXXXXA-A1			繪圖 DRAWN	Jeff 2015/09/08
	圖號 DRAWING NO.	GW006-GA787	版本 REV.	C	核對 CHECKED	Josh 2018/05/31
	客戶品號 CUSTOMER P/N		比例 SCALE	None	承認 APPROVED	Jason 2018/05/31
	公差 TOLERANCE	.X ±0.25 .XX ±0.13	單位 UNIT	mm	THIRD ANGLE PROJECTION	