

SPECIFICATIONS

Current Rating: 3 AMP
 Insulation Resistance: 1000MΩ Min.
 Contact Resistance: 30mΩ Max.
 Dielectric Voltage: 500V AC for one minute
 Operation Temperature: -55°C to +105°C

MATERIAL
 Insulator: PBT, UL94V-0
 Contact Pin: Copper Alloy
 Shell: SPCC.
 Screw: Iron.
 Rivet: Copper Alloy

ORDER INFORMATION

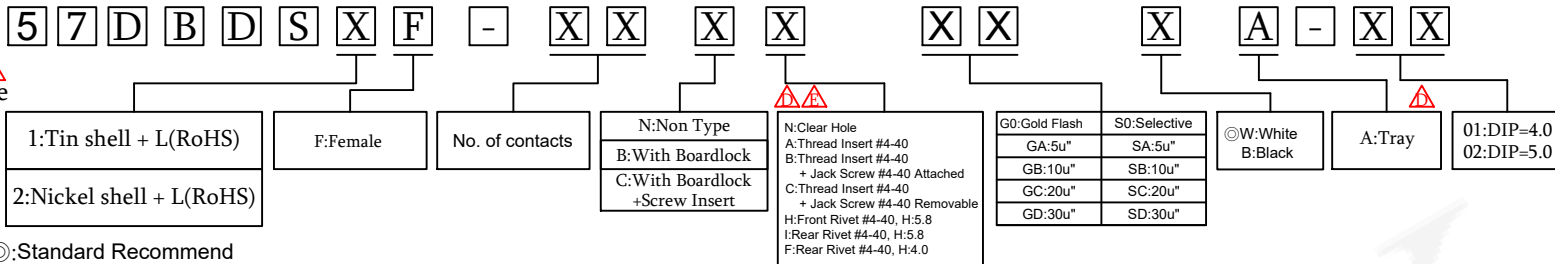

No.	A	B	C	D
09	30.81	24.99	16.33	19.15
15	39.14	33.32	24.75	27.65
25	53.04	47.04	38.33	41.10
37	69.32	63.50	54.75	57.33

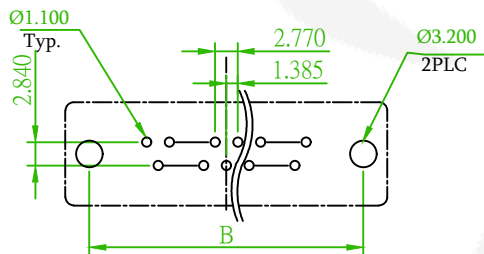
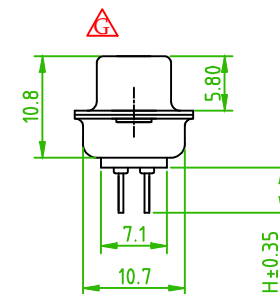
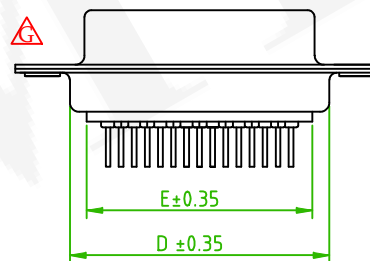
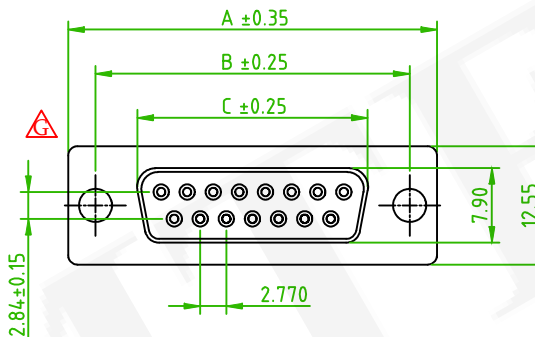

Recommended PCB Layout
 (PCB TOLERANCE ±0.05)

Old Part No.:DBD-FXX-L

△x9	ECN NO.: 221235 Revise the drawing	Benson	2023/02/18
△x1	ECN NO.: 220118 ,Add the mating face options	Benson	2022/02/22
△x2	Add accessories options	Benson	2021/07/30
REV.	ECN NO. OR DESCRIPTION	REVISED	DATE

 禮德精密有限公司 Amtek Technology Co., Ltd. TEL: 886-2-2260-6878 FAX: 886-2-2260-8030	品名 TITLE	D-SUB V/T DIP TYPE				頁數 Page	1/2
	品號 PART NO.	57DBDSXF-XXXXXXXXA-XX				繪圖 DRAWN	Roy 2016/10/27
	圖號 DRAWING NO.	GN010-RL006	版本 REV.	G	核對 CHECKED	Josh 2018/03/28	
	客戶品號 CUSTOMER P/N		比例 SCALE	None	承認 APPROVED	Jason 2018/03/28	
	公差 TOLERANCE	.X ±0.35 .XX ±0.25	單位 UNIT	mm	THIRD ANGLE PROJECTION		



AMTEK 糧德
2023.03.31
Released DCC

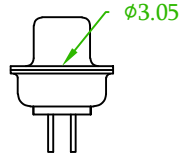

Clear Hole
57DBDSXF-XXNNXXXXA-XX

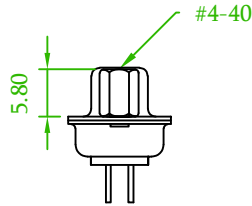

Front Rivet #4-40, H:5.8
57DBDSXF-XXNHXXXXA-XX

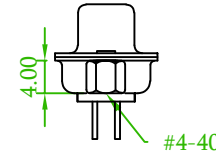

Rear Rivet #4-40, H:4.0
57DBDSXF-XXNFXXXXA-XX

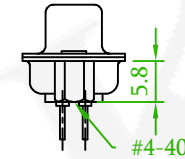

⚠ Rear Rivet #4-40, H:5.8
57DBDSXF-XXNIXXXXXA-XX

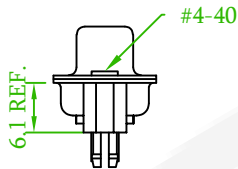

With Boardlock
+Thread Insert #4-40
57DBDSXF-XXBAXXXXXA-XX

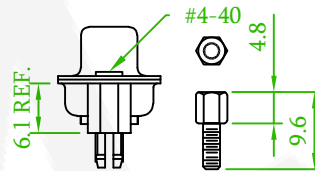

With Boardlock
+Thread Insert #4-40
+ Jack Screw #4-40 Attached ⚠
57DBDSXF-XXBBXXXXA-XX

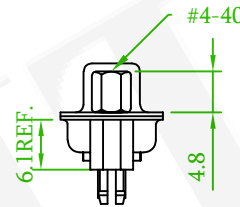

With Boardlock
+Thread Insert #4-40
+Jack Screw #4-40 Removable
57DBDSXF-XXCCXXXXA-XX

Old Part No.:DBD-FXX-L

⚠ x9	ECN NO.: 221235 Revise the drawing	Benson	2023/02/18
⚠ x1	ECN NO.: 220118 ,Add the mating face options	Benson	2022/02/22
⚠ x2	Add accessories options	Benson	2021/07/30
REV.	ECN NO. OR DESCRIPTION	REVISED	DATE

糧德精密有限公司
Amtek Technology Co., Ltd.
TEL: 886-2-2260-6878
FAX: 886-2-2260-8030

品名 TITLE	D-SUB V/T DIP TYPE				頁數 Page	2/2
品號 PART NO.	57DBDSXF-XXXXXXXXA-XX			繪圖 DRAWN	Roy 2016/10/27	
圖號 DRAWING NO.	GN010-RL006	版本 REV.	G	核對 CHECKED	Josh 2018/03/28	
客戶品號 CUSTOMER P/N		比例 SCALE	None	承認 APPROVED	Jason 2018/03/28	
公差 TOLERANCE	.X ±0.35 .XX ±0.25	單位 UNIT	mm	THIRD ANGLE PROJECTION		