

SPECIFICATIONS

Current Rating: 3 AMP
 Insulation Resistance: 1000MΩ Min.
 Contact Resistance: 20mΩ Max.
 Dielectric Voltage: 1000V AC for one minute
 Operation Temperature: -55°C to +105°C

MATERIAL

Insulator: PBT+ G. F., UL94V-0
 Terminal: Copper Alloy

ORDER INFORMATION

5 7 D B D S X F - X X X X X A - A 1



1: Tin shell + L(RoHS)
 2: Nickel shell + L(RoHS)

F: Female

No. of Contacts

Code	Boardlock	Mounting
NN	W/O	φ3.05 Clear Hole
NA	W/O	Thread Insert #4-40
NC	W/O	Thread Insert #4-40+Jack Screw #4-40 Removable
BA	With	Thread Insert #4-40
BB	With	Thread Insert #4-40+Jack Screw #4-40 Attached
BC	With	Thread Insert #4-40+Jack Screw #4-40 Removable
BU	With	Thread Insert M3

S0: Selective	SC: 20u"
SA: 5u"	SD: 30u"
SB: 10u"	T0: Tin Plated
TE: Tin 200u"	

◎W: Natural
 B: Black
 U: Blue

A: Tray

◎: Standard Recommend



No. of Contacts	Dimensions(mm)			
	A	B	C	D
09	30.81	24.99	16.33	11.08
15	39.20	33.30	24.70	19.39
25	53.05	47.04	38.40	33.24
37	69.40	63.50	54.80	49.86

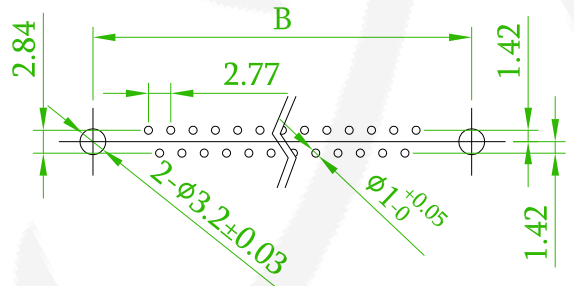
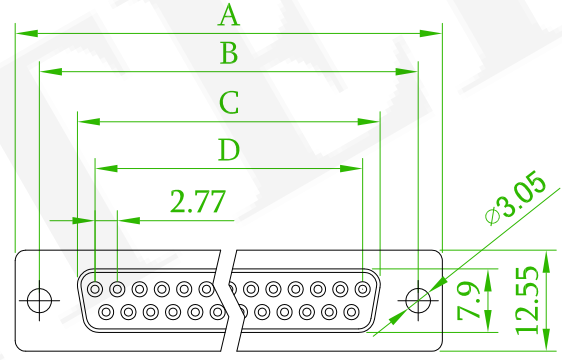

Recommended PCB Layout
 (PCB TOLERANCE ±0.05)

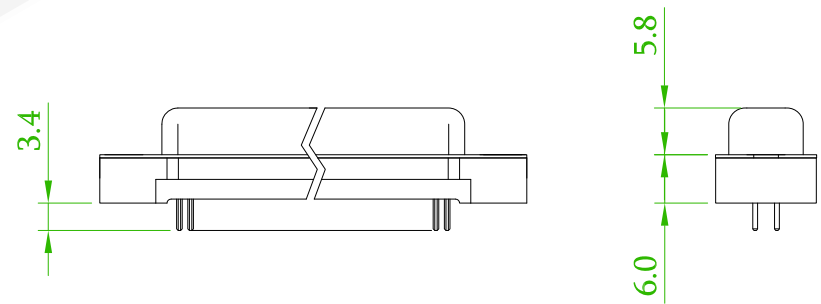

Old Part No.: DBDA-FXX-L

REV.	ECN NO. OR DESCRIPTION	REVISED	DATE
△ x1	ECN NO.: 181215, remove platings: G0, GA, GB, GC, GD.	Gary	2019/01/24
△ x3	ECN NO.: 180904, add an association of accessory: BU, revise the code: CC -> BC.	Gary	2018/10/08
△ x2	Revise the drawing.	Roy	2016/10/07

品名 TITLE	D-SUB V/T DIP TYPE				頁數 Page	1/2
	品號 PART NO.	57DBDSXF-XXXXXXXXA-A1			繪圖 DRAWN	Jeff
圖號 DRAWING NO.	GW006-GB384	版本 REV.	C	核對 CHECKED	Josh	
客戶品號 CUSTOMER P/N		比例 SCALE	None	承認 APPROVED	Jason	
公差 TOLERANCE	.X ±0.25 .XX ±0.13	單位 UNIT	mm	THIRD ANGLE PROJECTION		

糧德精密有限公司
 Amtek Technology Co., Ltd.
 TEL: 886-2-2260-6878
 FAX: 886-2-2260-8030

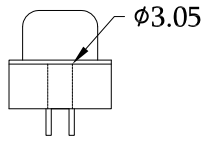

W/O Boardlock
 Ø3.05 Clear Hole
 57DBDSXF-XXNNXXXXA-A1

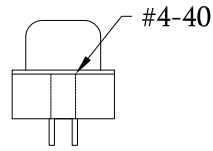

W/O Boardlock
 Thread Insert #4-40
 57DBDSXF-XXNAXXXA-A1

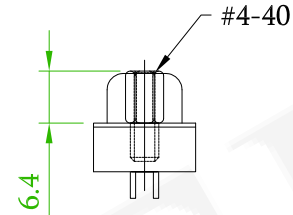

W/O Boardlock
 Thread Insert #4-40
 +Jack Screw #4-40 Removable
 57DBDSXF-XXNCXXXXA-A1

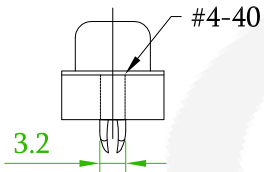

With Boardlock
 Thread Insert #4-40
 57DBDSXF-XXBAXXXA-A1

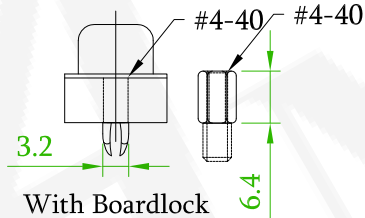

With Boardlock
 Thread Insert #4-40
 +Jack Screw #4-40 Attached
 57DBDSXF-XXBBXXA-A1

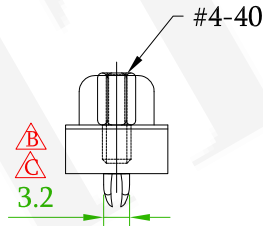

With Boardlock
 Thread Insert #4-40
 +Jack Screw #4-40 Removable
 57DBDSXF-XXBCXXA-A1

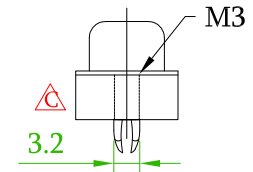

With Boardlock
 Thread Insert M3
 57DBDSXF-XXBUXXXA-A1

Old Part No.:DBDA-FXX-L

△ x1	ECN NO.: 181215, remove platings: G0, GA, GB, GC, GD.	Gary	2019/01/24
△ x3	ECN NO.: 180904, add an association of accessory: BU, revise the code: CC -> BC.	Gary	2018/10/08
△ x2	Revise the drawing.	Roy	2016/10/07
REV.	ECN NO. OR DESCRIPTION	REVISED	DATE

Amtek Technology Co., Ltd.
 糧德精密有限公司
 TEL: 886-2-2260-6878
 FAX: 886-2-2260-8030

品名 TITLE	D-SUB V/T DIP TYPE				頁數 Page	2/2
品號 PART NO.	57DBDSXF-XXXXXXA-A1			繪圖 DRAWN	Jeff 2015/09/08	
圖號 DRAWING NO.	GW006-GB384	版本 REV.	D	核對 CHECKED	Josh 2019/01/24	
客戶品號 CUSTOMER P/N		比例 SCALE	None	承認 APPROVED	Jason 2019/01/24	
公差 TOLERANCE	.X ±0.25 .XX ±0.13	單位 UNIT	mm	THIRD ANGLE PROJECTION		