

NOTE

Material: BeCu

Thickness: 0.08mm

Electroplate:

Gold Flash on contact area

Gold Flash on solder area

Nickel underplating over all

Height of Application:

0.90 to 1.15mm (Single Actuation)

1.00 to 1.15mm (Repeated Actuation)

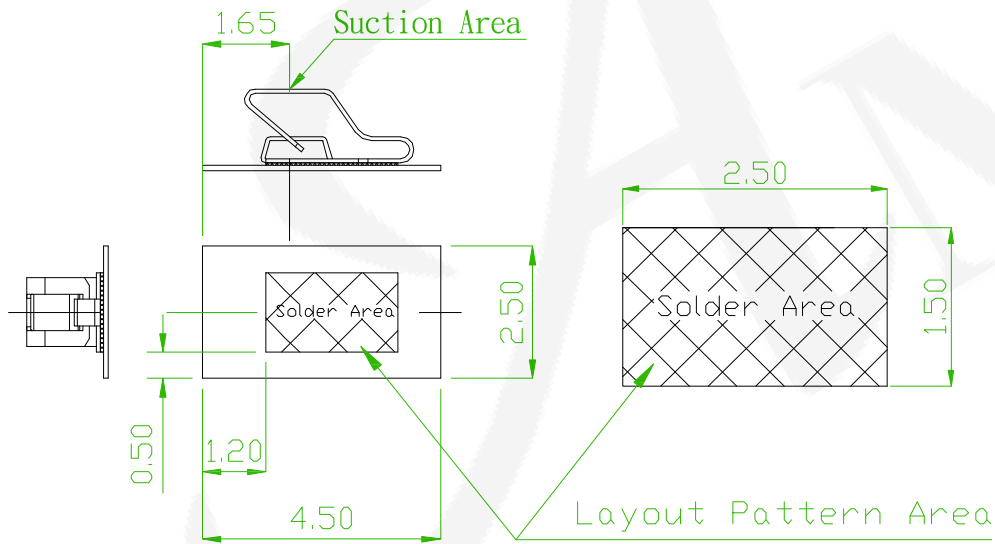
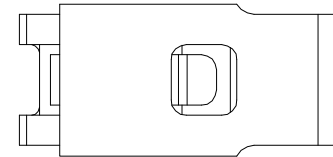
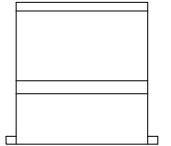
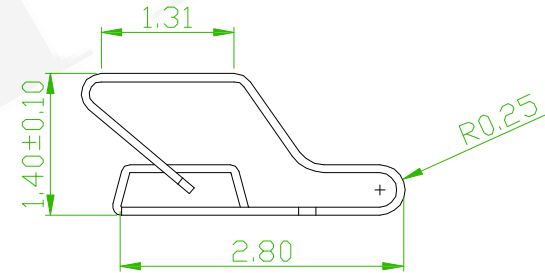
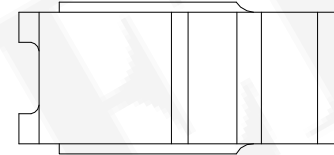
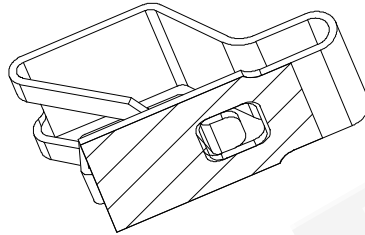
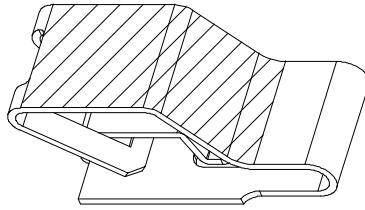

Recommended PCB Layout
(PCB TOLERANCE ± 0.1)

REV.	ECN NO. OR DESCRIPTION	REVISED	DATE



耀德精密有限公司
Amtek Technology Co., Ltd.
TEL: 886-2-2260-6878
FAX: 886-2-2260-8030

品名 TITLE	EMI SPRING				頁數 Page	1/1
品號 PART NO.	3SSQ-NN14NN-NNA1G			繪圖 DRAWN	Elisa 2019/03/14	
圖號 DRAWING NO.	GW271-EI011	版本 REV.	A	核對 CHECKED	Josh 2019/03/14	
客戶品號 CUSTOMER P/N		比例 SCALE	None	承認 APPROVED	Josh 2019/03/14	
公差 TOLERANCE	± 0.20	單位 UNIT	mm	THIRD ANGLE PROJECTION	