

NOTE

Material: Be-Cu

Thickness: 0.08mm

Plated: Gold Flash on Contact area

Gold Flash on Solder area

Nickel Underplating over All

Height of Application: 2.90 to 3.80mm (Single Actuation)

2.80 to 3.80mm (Repeated Actuation)

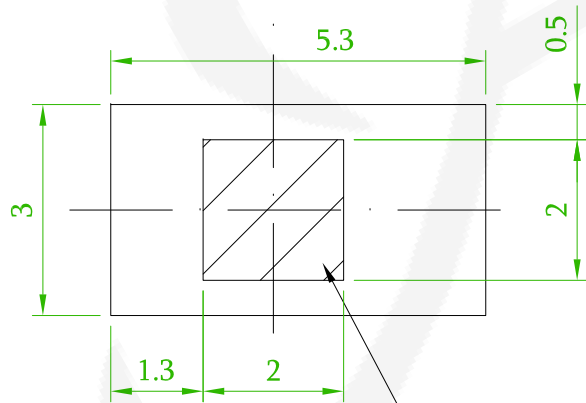
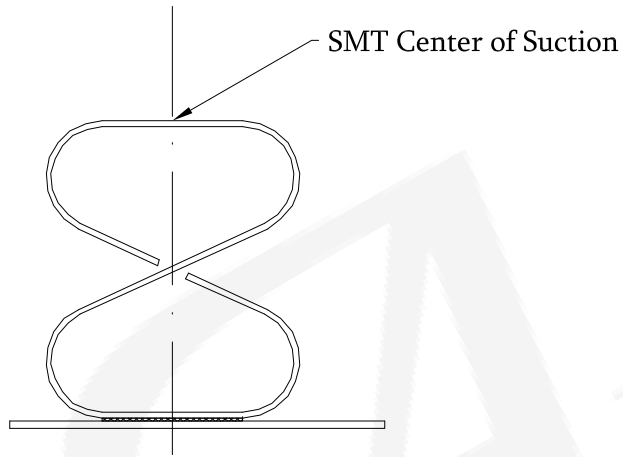

Solder Area

Recommended PCB Layout
(PCB TOLERANCE ±0.1)

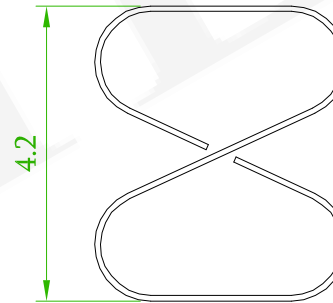
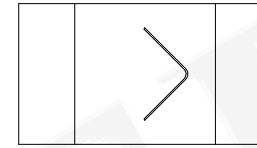
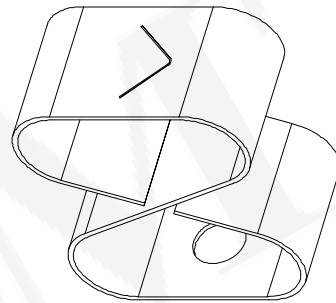

4.2

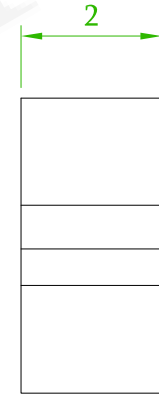

2

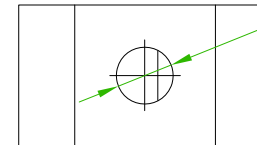

∅0.8

REV.	ECN NO. OR DESCRIPTION	REVISED	DATE

糧德精密有限公司
Amtek Technology Co., Ltd.
TEL: 886-2-2260-6878
FAX: 886-2-2260-8030

品名 TITLE		EMI SPRING				頁數 Page	1/1
品號 PART NO.	3SS8-NN42NN-NNNNG				繪圖 DRAWN	Gary 2018/05/03	
圖號 DRAWING NO.	GW271-GB115	版本 REV.	A	核對 CHECKED	Josh 2018/05/03		
客戶品號 CUSTOMER P/N		比例 SCALE	None	承認 APPROVED	Jason 2018/05/03		
公差 TOLERANCE	±0.20	單位 UNIT	mm	THIRD ANGLE PROJECTION			