

NOTE

Material: Copper Alloys

Thickness: 0.12mm

Electroplate:

Au >1u" plating on Contact Area

Gold Flash on Solder Area

Nickel Underplating over All

Height of Application:

0.8 to 1.3mm (Single Actuation)

1.0 to 1.3mm (Repeated Actuation)

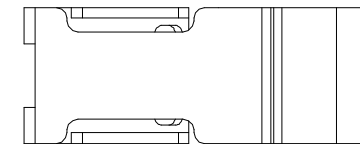
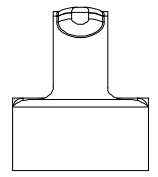
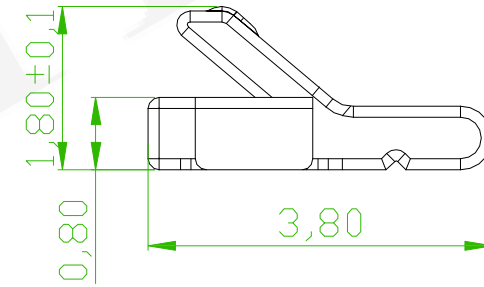
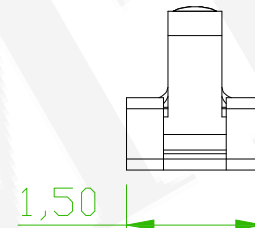
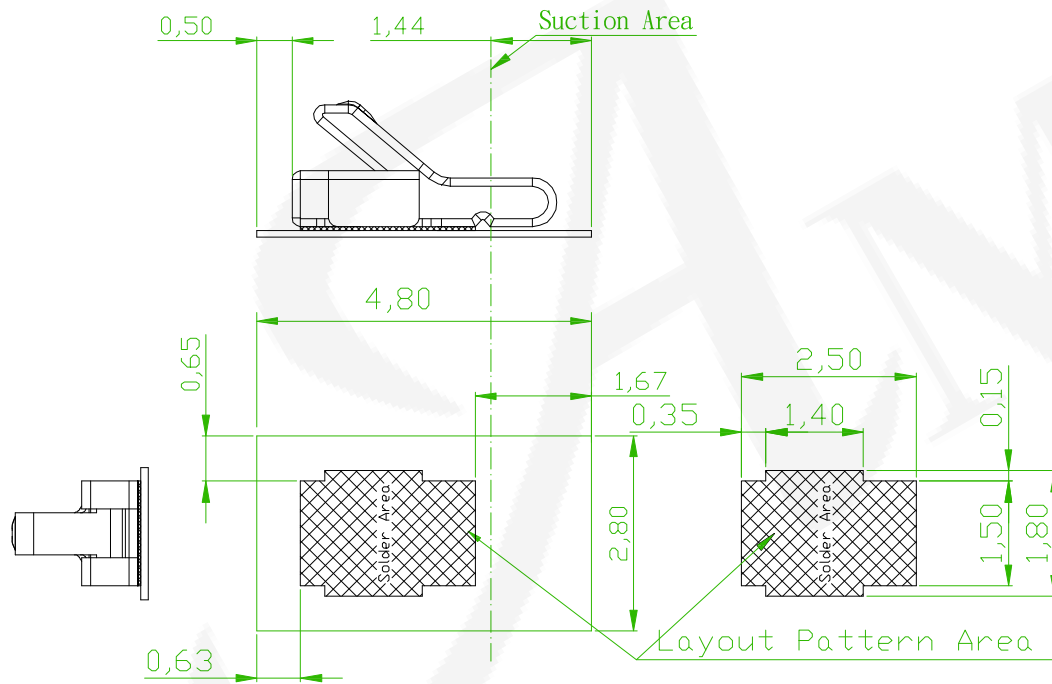
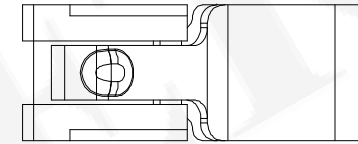
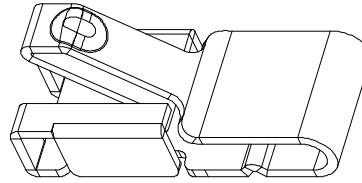

Recommended PCB Layout
(PCB TOLERANCE ±0.1)

REV.	ECN NO. OR DESCRIPTION	REVISED	DATE

糧德精密有限公司
Amtek Technology Co., Ltd.
TEL: 886-2-2260-6878
FAX: 886-2-2260-8030

品名 TITLE	EMI SPRING				頁數 Page	1/1
品號 PART NO.	3SQM-NN18NN-NNQ1G				繪圖 DRAWN	Elisa 2019/03/15
圖號 DRAWING NO.	GW271-EI017	版本 REV.	A	核對 CHECKED	Josh 2019/03/15	
客戶品號 CUSTOMER P/N		比例 SCALE	None	承認 APPROVED	Josh 2019/03/15	
公差 TOLERANCE	±0.20	單位 UNIT	mm	THIRD ANGLE PROJECTION		