

Modular Jack Side Entry H=15.4 W=16

Material & Finish:
 Housing:PBT. UL94V-0,Gary,Mixed Glass Fiber
 Contact:0.45 mm Diameter Phosphor Bronze,
 Plated With Hard Gold.

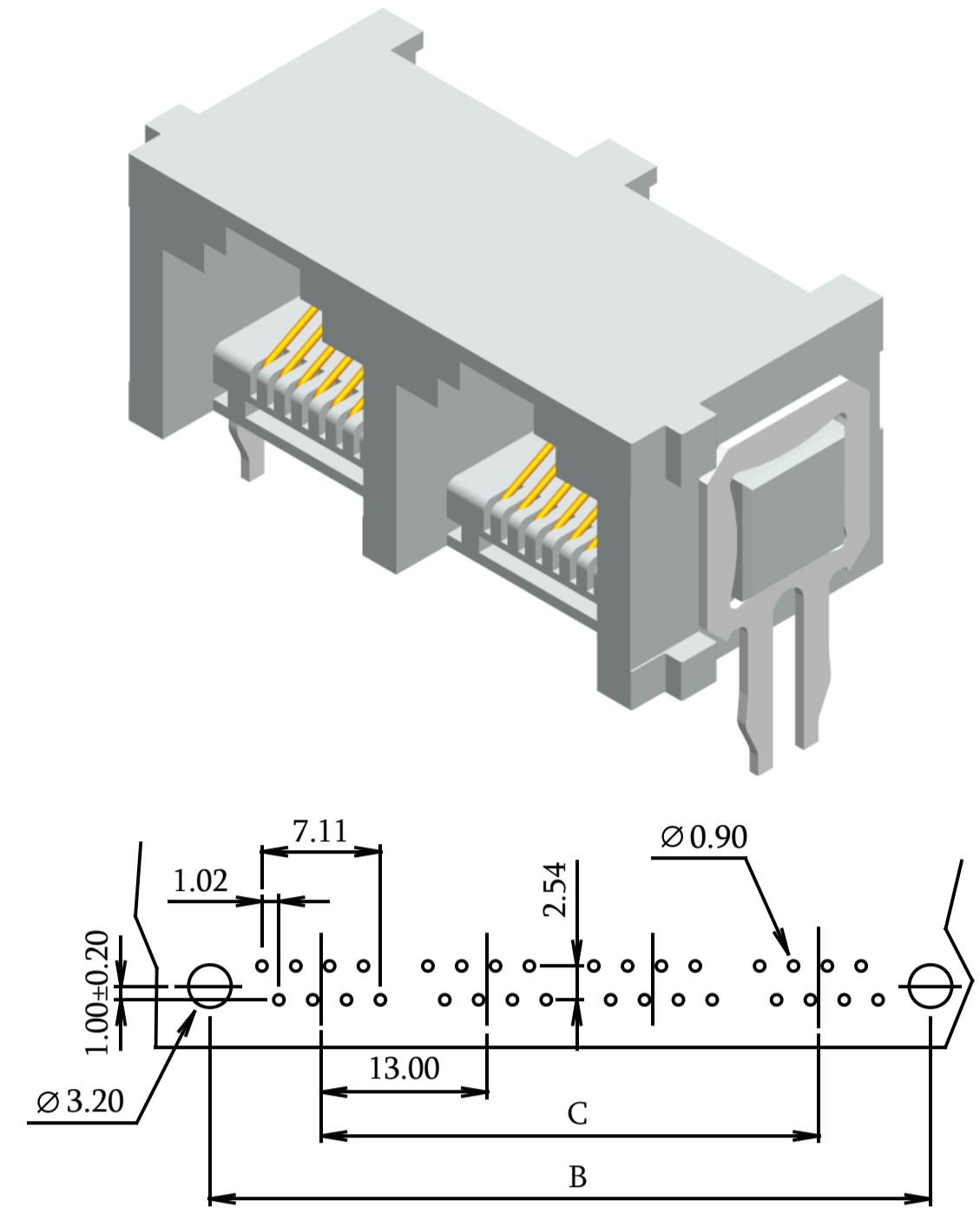

PC Board Layout

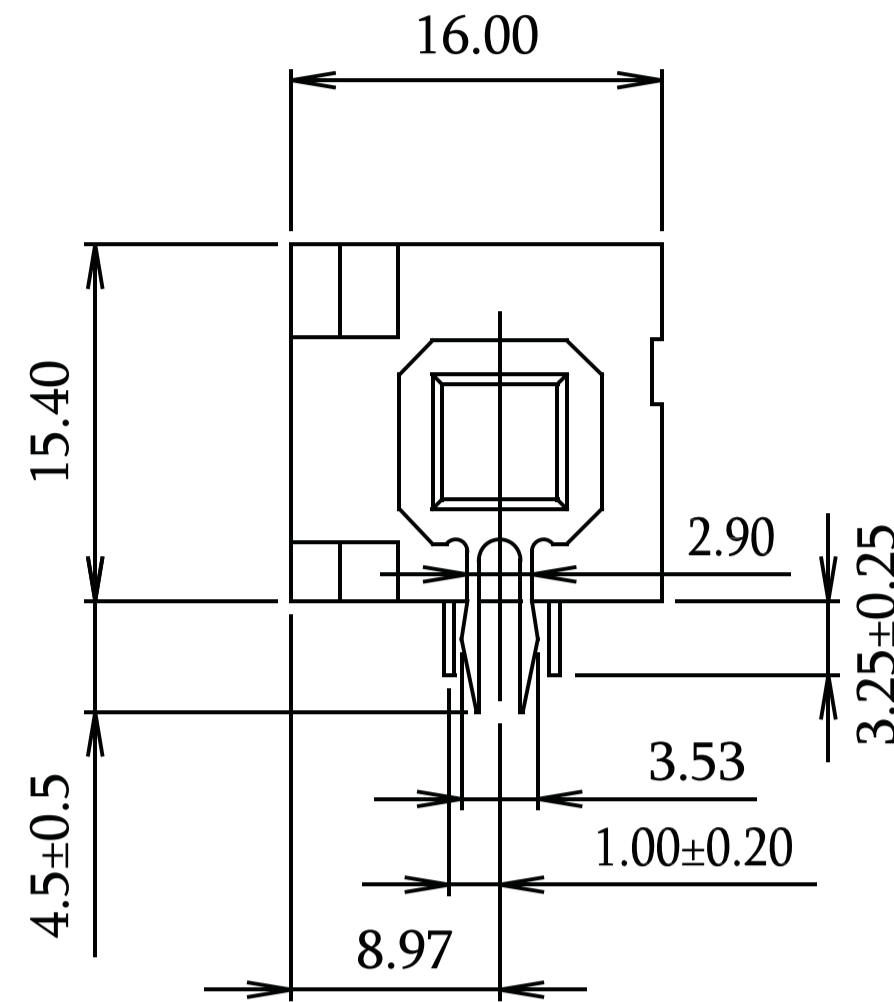
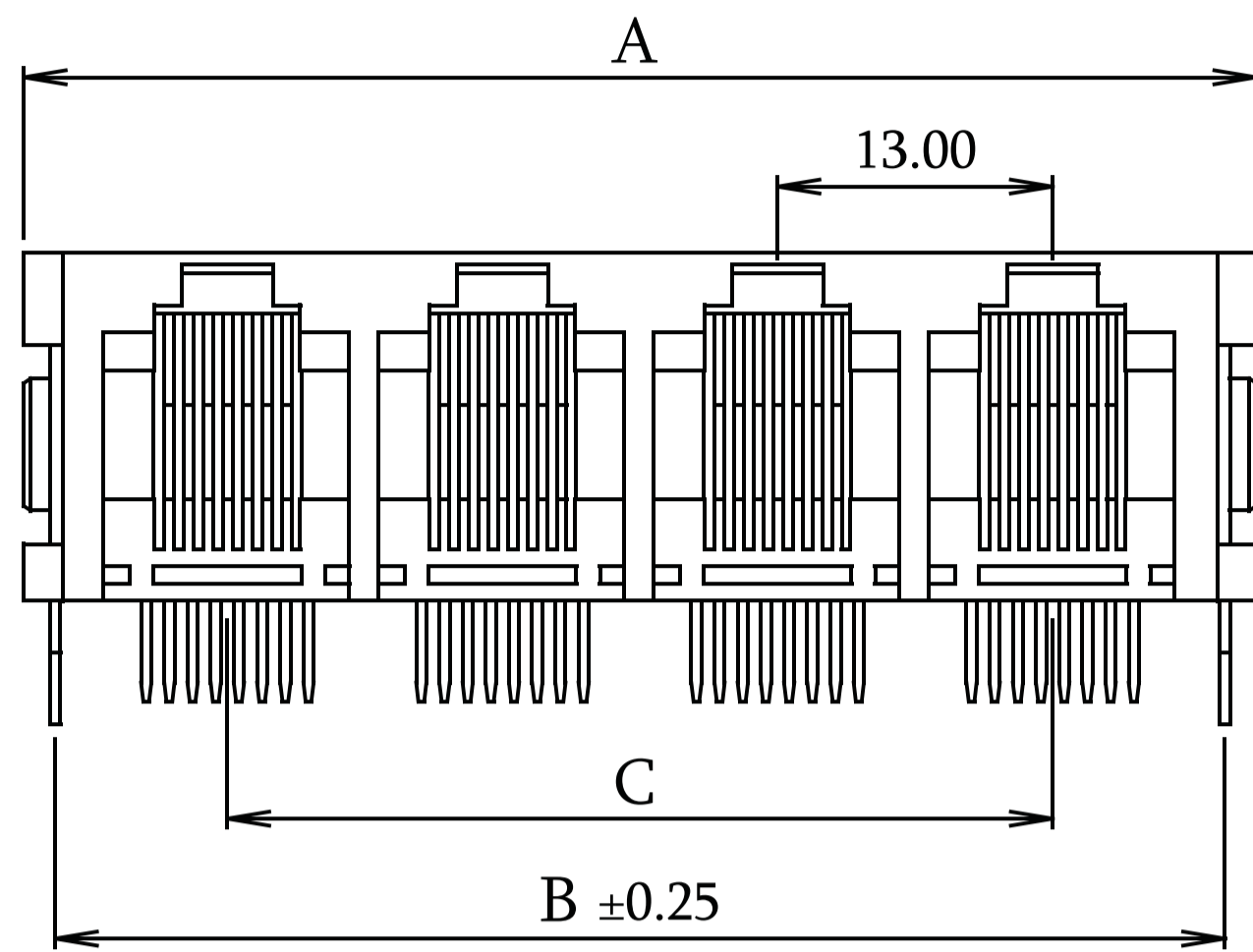
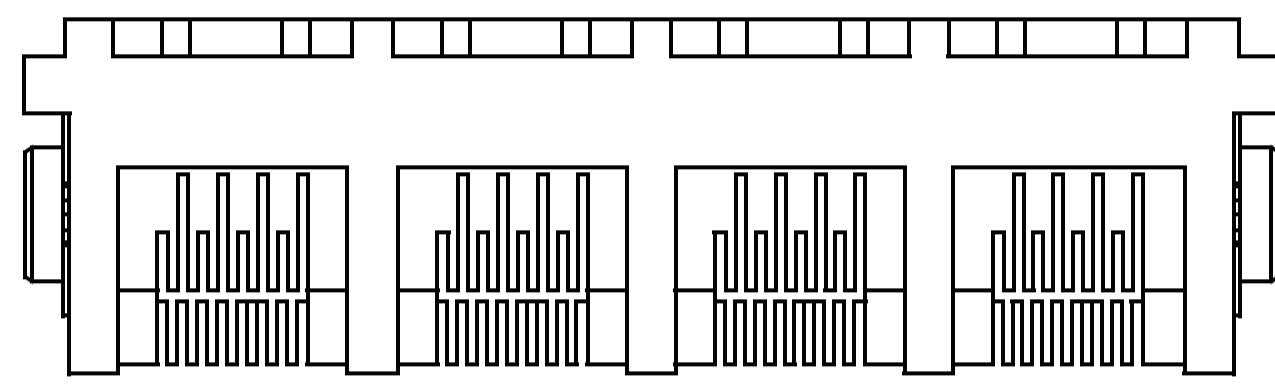

DIMENSION	NO. OF JACK			
	1	2	3	4
A	19.28	32.28	45.28	58.28
B	16	29	42	55
C		13.00	26.00	39.00

Order Information

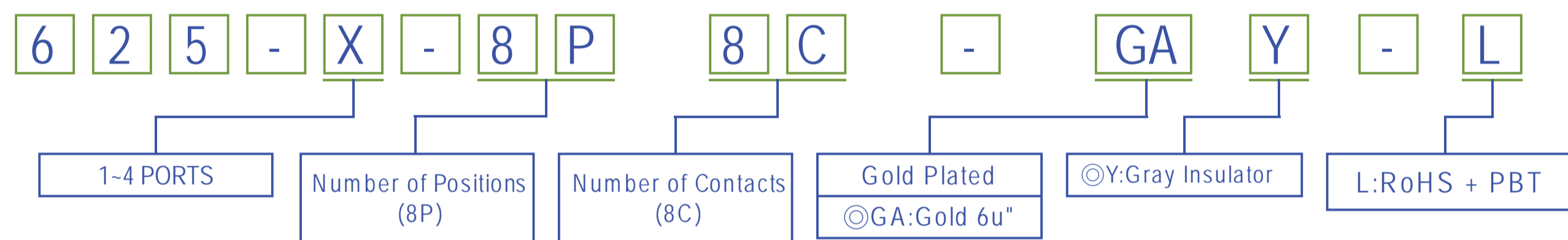

Modular Jack Side Entry H=14.5 W=15.0

Material & Finish:
 Housing:Glass Fiber,PBT. UL94V-0,Black
 Contact:0.45 mm Thickness Phosphor Bronze,
 Gold Plating Over Nickel on Contact Area,
 Tin Plating Over Nickel on Solder Area.

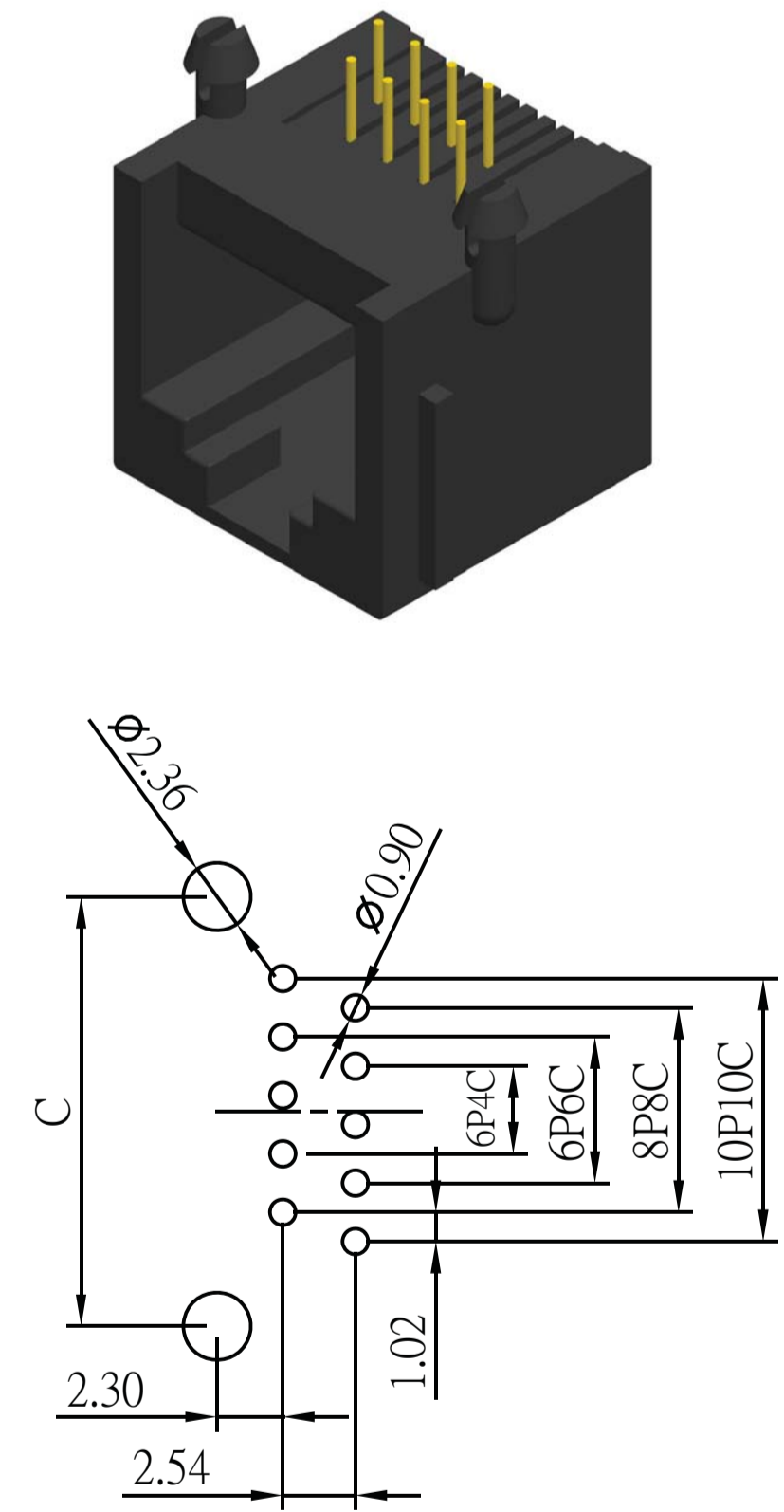
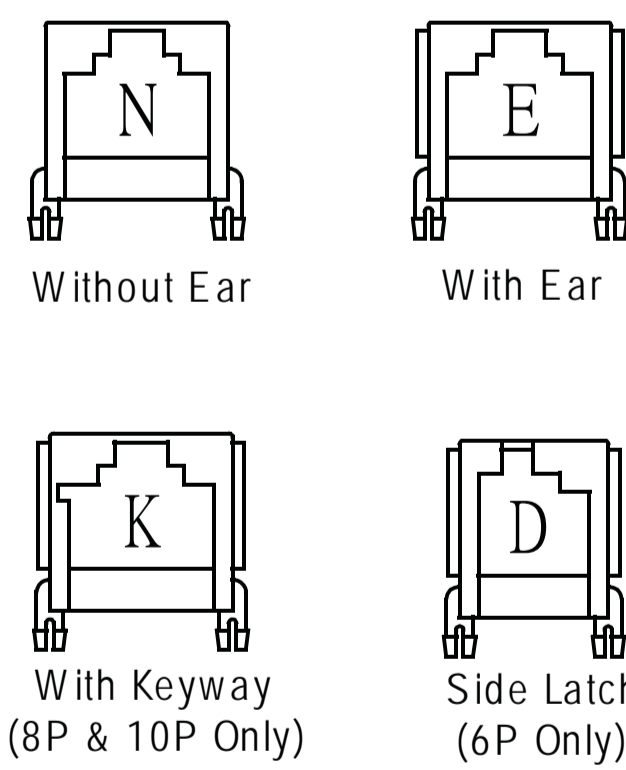
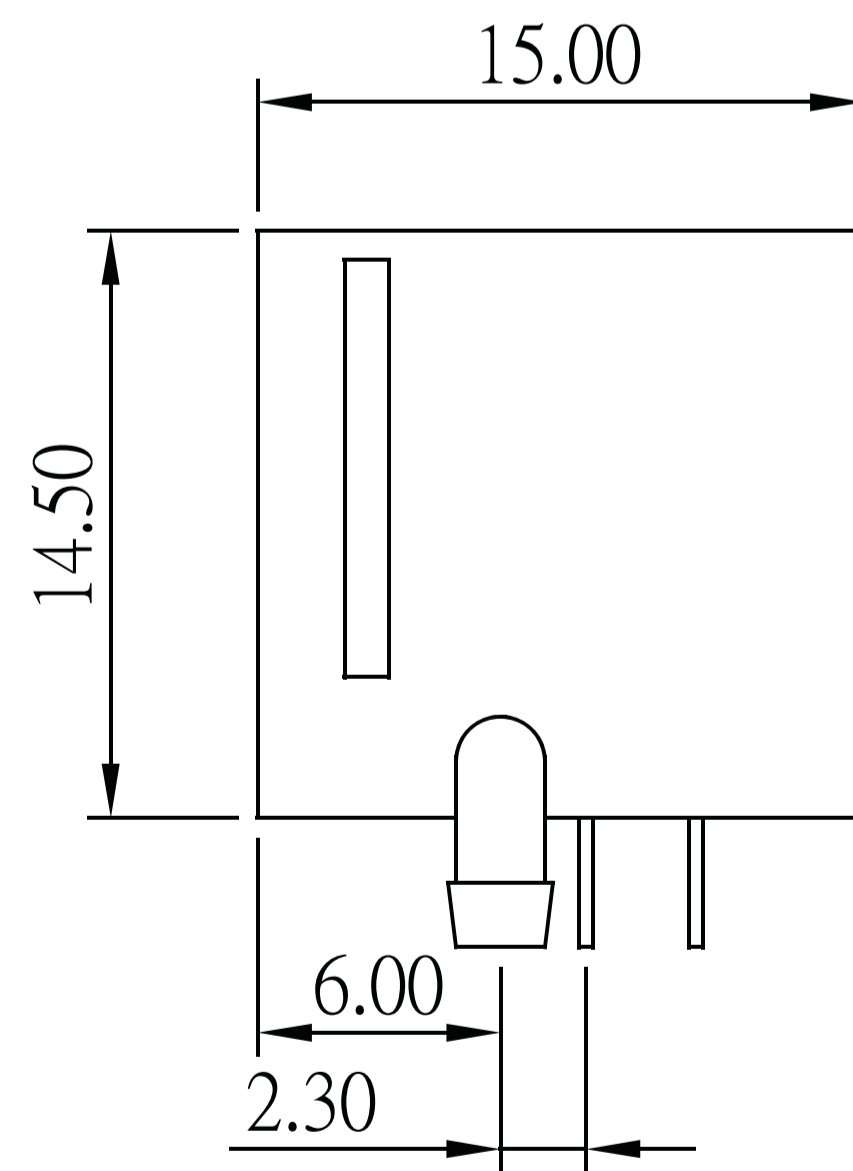
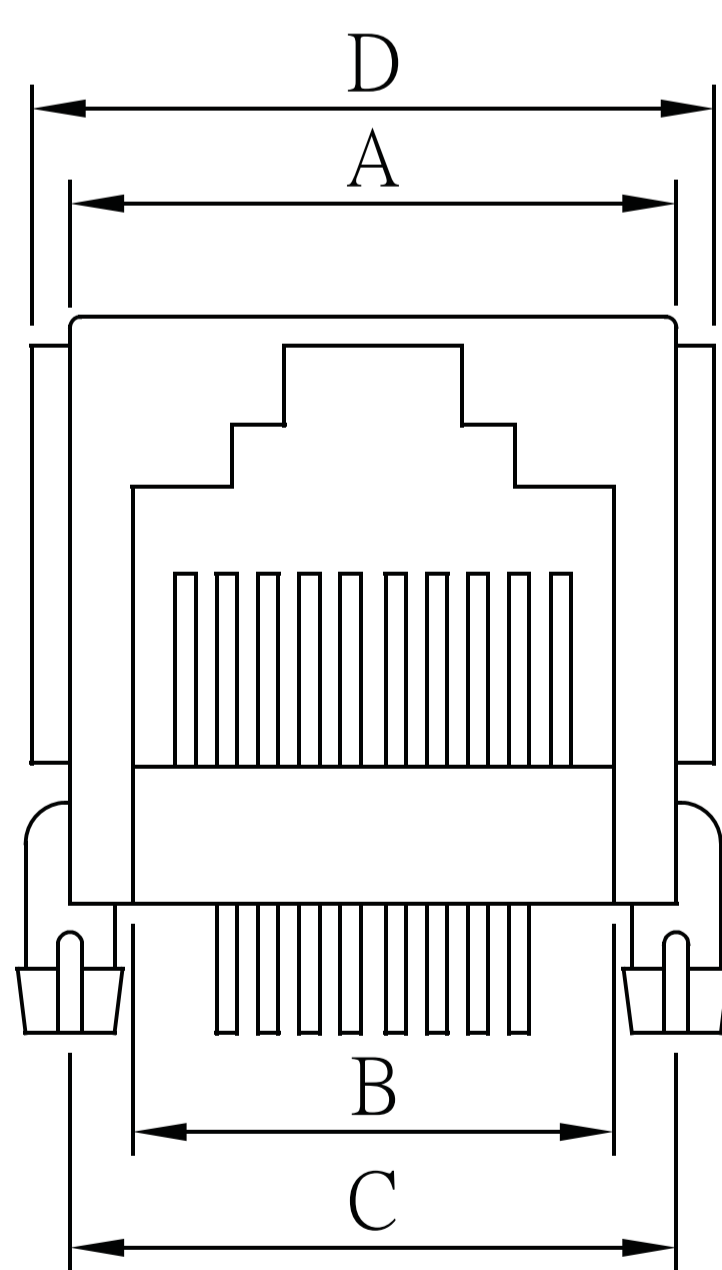

Recommended PCB Layout
 (PCB TOLERANCE ±0.05)

Positions	Contacts	A	B	C	D
4P	4C	10.00	7.85	10.00	12.00
(6P)4P	4C	12.20	7.85	12.00	14.20
6P	2C/4C/6C	12.20	9.90	12.00	14.20
8P	8C	15.00	11.85	15.00	16.90
10P	10C	15.00	11.85	15.00	16.90

Order Information

